

Calculite® HID Adjustable Accent **C4T4A-MHT4RS**

Page 1 of 4

4 1/2" Aperture, T4, Ceramic Metal Halide, 12° Spot



Spot Upper Reflector

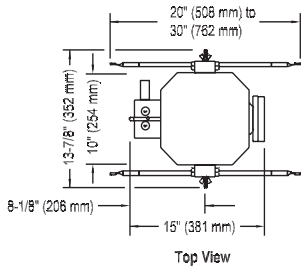

Top View

Ceiling Cutout: 5 1/8" (130mm) Dia.

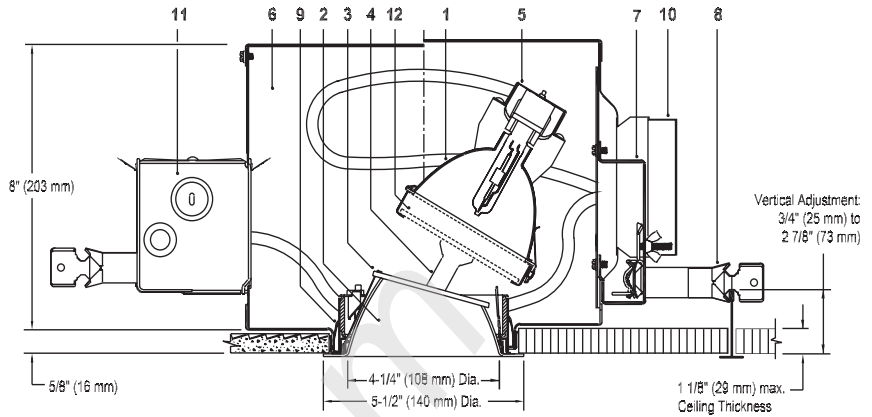

For Complete Fixture Order: Trim Kit + Spot Upper Reflector (MHT4RS) + Frame-In Kit. Each Sold Separately.

Trim Kit + Spot Upper Reflector	Frame-In Kit	Lamping (Ceramic Metal Halide)
C4T4A <input type="checkbox"/> + MHT4RS (Spot Upper Reflector)		
CLW Specular Clear, White Painted Flange	C4A20BT5PGJ5E1 Electronic 120V	22W Philips MiniMasterColor
CCDW Comfort Clear Diffuse, White Painted Flange	C4A20T4GU65EU Electronic 120V/277V	20W GE ConstantColor
CCDP Comfort Clear Diffuse, Matching Flange	C4A20T4EU Electronic 120V/277V	20W T4.5
CCZW Champagne Bronze, White Painted Flange	C4A39T4GU65EU Electronic 120V/277V	39W Philips MiniMasterColor
CCZP Champagne Bronze, Matching Flange	C4A39T4E1 Electronic 120V	39W T4.5
	C4A39T4E2 Electronic 277V	39W T4.5
	C4A70T4E1 Electronic 120V	70W T4.5
	C4A70T4E2 Electronic 277V	70W T4.5

Features

- Spot Upper Reflector:** Specular faceted aluminum; provides 12° beam. Interchangeable with 25° Narrow Flood (MHT4RNF) and 40° Flood (MHT4RF); see spec sheets C4T4A-MHT4RNF and C4T4A-MHT4RF.
- Trim Kit:** Low brightness aperture cone; anodized aluminum, self-flanged in painted white or aperture-matching polished flange. Consult factory for other finishes.
- Lamp Shield:** High-temperature glass as required by code; captive during re-lamping.
- Trim Kit Adjustment Mechanism:** Provides 35° vertical tilt, 360° horizontal rotation; lockable. EZ-Aim Helical Drive System provides fast and accurate hot aiming with Philips screwdriver.
- Socket Housing:** Galvanized steel, pre-wired with G8.5 pulse rated socket. Snaps onto yoke for secure attachment without tools; unitized construction assures proper alignment of lamp to optics for consistent optical performance.
- Frame Housing:** Steel, 0.029" (22-Ga.), matte black finish. Removable cover for top re-lamping.
- Frame Vertical Adjustment Mechanism:** Accommodates mounting to virtually any ceiling system using pre-installed mounting bars, or 1/2" EMT tubing (by others). Single locking feature secures all adjustments. Alignment holes and markings allow fixture to be pre-set prior to installation. Final adjustment can be made from below from inside fixture.
- Mounting Bars:** Galvanized steel, 0.048" (18-ga.), pre-installed telescoping bars extend to 30" long and lock securely into position. Built-in locking tabs provide positive attachment to common T-bar systems. Self-centering feature simplifies installation in 24" O.C. grid systems. Attaches to steel or wood joists without accessories.
- Retention Springs:** Rust resistant springs secure trim for quick, tool-less installation.
- Ballast / Cover Assembly:** Accessible from below and removable without tools for inspection and ballast replacement.
- Junction Box:** 0.059" (16-ga.) galvanized steel. UL listed for 8 No. 12 AWG, 90° C through branch circuit conductors. Allows inspection from below.

Features (continued)

- Optional Accessory Holder:** Sold separately catalog # CAH4; die-formed steel, matte black finish, slide-in installation. Accepts up to two 3 3/4" dia. media.
- Thermal Protector:** (Not Shown) Meets NEC and UL requirements. Do not install insulation above nor within 3" (76mm) of any part of the luminaire.

Electrical

Electronic Ballast: 120V or 277V, 50/60 Hz., encased, high power factor, T.H.D. <15%, thermally and transient protected, RMI/RFI complies with FCC Part 18 non-consumer limits, shut-down circuit at end of lamp life, sound rating "A", -5° F minimum starting temperature, Type 1 Outdoor rating.

Ballast	ANSI Code	Voltage	Max. Amps	Input Watts
20W MH	M156	120/277	0.21/0.10	23
39W MH	M130	120/277	0.39/0.17	44
70W MH	M139	120/277	0.67/0.29	78

Options and Accessories

Chicago Plenum: Consult Factory

Labels

UL (Suitable for Damp Locations), CSA, I.B.E.W.

Job Information	Type:
Job Name:	
Cat. No.:	
Lamp(s):	
Notes:	

Calculite® HID Adjustable Accent **C4T4A-MHT4RS**

(FC) is initial footcandles at center of beam. Beam length (L) and beam width (W) are to where the candlepower is reduced to 50% of the center beam candlepower. (C) is the distance to the center of the beam.

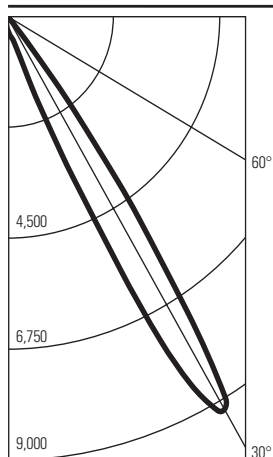
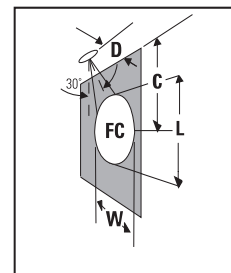
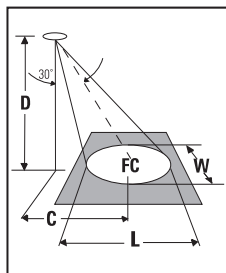

ANGLE	WALL	AIMED 30° TOWARD WALL
0	224	
5	305	T4 20W G.E. METAL HALIDE LAMP
10	411	LUMEN RATING = 1700 LMS.
15	504	
20	1527	CBCP= 9,201cd
25	5611	BEAM ANGLE = 11°
30	9201	AROMAT 20W ELECTRONIC BALLAST
35	4107	
40	426	DATE: OCT 30, 2003
45	66	CERTIFIED TEST REPORT NO. 2351FR
50	20	COMPUTED BY LSI PROGRAM
55	8	**TEST-LITE**
60	3	
65	0	
70	0	
75	0	
80	0	
85	0	
90	0	

Candlepower Distribution 20W Lamp t4.5 – Spot Upper Reflector

30° Aiming Angle Horizontal Surface					30° Aiming Angle Vertical Surface				
D	C	FC	L	W	D	C	FC	L	W
6'	3.5'	166	1.5'	1.3'	2'	3.5'	288	1.6'	0.8'
8'	4.6'	93	2.1'	1.8'	3'	5.2'	128	2.4'	1.2'
10'	5.8'	60	2.6'	2.2'	4'	6.9'	72	3.2'	1.5'
12'	6.9'	42	3.1'	2.7'	6'	10.4'	32	4.8'	2.3'
15'	8.7'	27	3.9'	3.3'	8'	13.9'	18	6.3'	3.1'

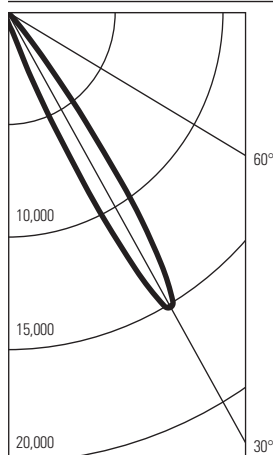

ANGLE	WALL	AIMED 30° TOWARD WALL
0	359	
5	474	T4 39W PHILIPS METAL HALIDE LAMP
10	646	LUMEN RATING = 3300 LMS.
15	886	
20	2519	CBCP= 15,143 cd
25	8378	BEAM ANGLE = 12°
30	15143	AROMAT 39W ELECTRONIC BALLAST
35	9185	
40	2124	DATE: OCT 30, 2003
45	379	CERTIFIED TEST REPORT NO. 2350FR
50	59	COMPUTED BY LSI PROGRAM
55	16	**TEST-LITE**
60	0	
65	0	
70	0	
75	0	
80	0	
85	0	
90	0	

Candlepower Distribution 39W T4.5 – Spot Upper Reflector

30° Aiming Angle Horizontal Surface					30° Aiming Angle Vertical Surface				
D	C	FC	L	W	D	C	FC	L	W
8'	4.6'	154	2.3'	1.9'	3'	5.2'	210	2.6'	1.3'
10'	5.8'	98	2.8'	2.4'	4'	6.9'	118	3.5'	1.7'
12'	6.9'	68	3.4'	2.9'	6'	10.4'	53	5.2'	2.5'
15'	8.7'	44	4.2'	3.6'	8'	13.9'	30	7.0'	3.4'
20'	11.5'	25	5.6'	4.9'	12'	20.8'	13	10.4'	5.0'

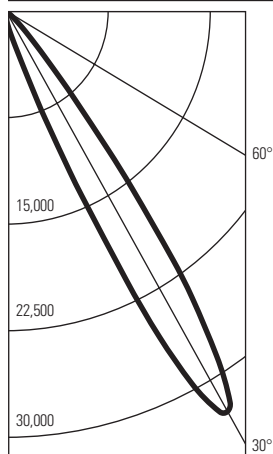

ANGLE	WALL	AIMED 30° TOWARD WALL
0	569	
5	804	T4 70W PHILIPS METAL HALIDE LAMP
10	1315	LUMEN RATING = 6400 LMS.
15	2448	
20	6705	CBCP= 32,535 cd
25	20862	BEAM ANGLE = 13°
30	32535	AROMAT 70W ELECTRONIC BALLAST
35	21397	
40	6307	DATE: OCT 25, 2003
45	1906	CERTIFIED TEST REPORT NO. 2345FR
50	472	COMPUTED BY LSI PROGRAM
55	73	**TEST-LITE**
60	23	
65	7	
70	0	
75	0	
80	0	
85	0	
90	0	

Candlepower Distribution 70W T4.5 – Spot Upper Reflector

30° Aiming Angle Horizontal Surface					30° Aiming Angle Vertical Surface				
D	C	FC	L	W	D	C	FC	L	W
8'	4.6'	330	2.4'	2.1'	3'	5.2'	452	2.8'	1.4'
10'	5.8'	211	3.1'	2.6'	4'	6.9'	254	3.8'	1.8'
12'	6.9'	147	3.7'	3.2'	6'	10.4'	113	5.7'	2.7'
15'	8.7'	94	4.6'	3.9'	8'	13.9'	64	7.6'	3.6'
20'	11.5'	53	6.1'	5.3'	12'	20.8'	28	11.4'	5.5'

Job Information **Type:**

Calculite® HID Adjustable Accent **C4T4A-MHT4RS**

22W PGJ5 Philips MiniMastercolor CMH Lamp, **Spot** Upper Reflector, Lumen Rating = 1650 lms, Aromat Electronic Ballast

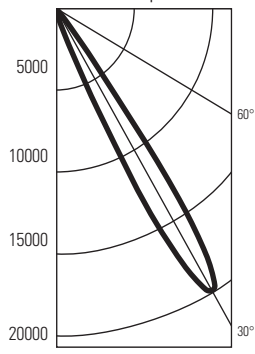

Angle	Wall
0	148
5	331
10	359
15	581
20	2099
25	11595
30	19895
35	9590
40	979
45	87
50	16
55	0
60	0
65	0
70	0
75	0
80	0
85	0
90	0

30° Aiming Angle Horizontal Surface					30° Aiming Angle Vertical Surface				
D	C	FC	L	W	D	C	FC	L	W
6'	3.5'	359	1.5'	1.3'	2'	3.5'	622	1.6'	0.8'
8'	4.6'	202	2.1'	1.8'	3'	5.2'	276	2.4'	1.2'
10'	5.8'	129	2.6'	2.2'	4'	6.9'	155	3.2'	1.5'
12'	6.9'	90	3.1'	2.7'	6'	10.4'	69	4.8'	2.3'
15'	8.7'	57	3.9'	3.3'	8'	13.9'	39	6.3'	3.1'

Certified Test Report No. 3817FR, Date: Oct 16, 2008. Computed by LSI Program **Test-Lite**

39W PGJ5 Philips MiniMastercolor CMH Lamp, **Spot** Upper Reflector, Lumen Rating = 3000 lms, Aromat Electronic Ballast

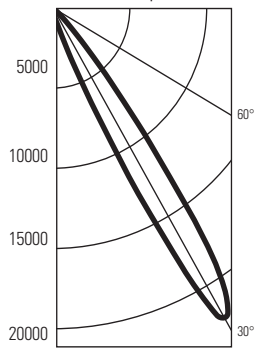

Angle	Wall
0	281
5	433
10	605
15	968
20	2995
25	11133
30	22294
35	15400
40	4816
45	1120
50	166
55	20
60	0
65	0
70	0
75	0
80	0
85	0
90	0

30° Aiming Angle Horizontal Surface					30° Aiming Angle Vertical Surface				
D	C	FC	L	W	D	C	FC	L	W
6'	3.5'	402	1.7'	1.5'	2'	3.5'	697	1.7'	0.8'
8'	4.6'	226	2.3'	1.9'	3'	5.2'	310	2.6'	1.3'
10'	5.8'	145	2.8'	2.4'	4'	6.9'	174	3.5'	1.7'
12'	6.9'	101	3.4'	2.9'	6'	10.4'	77	5.2'	2.5'
15'	8.7'	64	4.2'	3.6'	8'	13.9'	44	7.0'	3.4'

Certified Test Report No. 3942FR, Date: Oct 16, 2008. Computed by LSI Program **Test-Lite**

Job Information Type:

Calculite® HID Adjustable Accent **C4T4A-MHT4RS**

20W GU6.5 GE Constantcolor CMH Lamp, **Spot** Upper Reflector, Lumen Rating = 1615 lms, Aromat Electronic Ballast

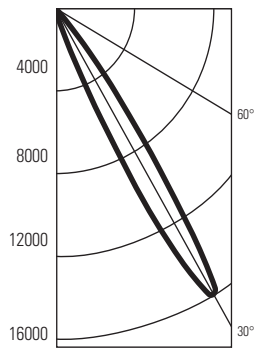

Angle	Wall
0	132
5	230
10	332
15	407
20	1894
25	9084
30	15966
35	7634
40	1769
45	213
50	34
55	0
60	0
65	0
70	0
75	0
80	0
85	0
90	0

30° Aiming Angle Horizontal Surface					30° Aiming Angle Vertical Surface				
D	C	FC	L	W	D	C	FC	L	W
6'	3.5'	288	1.5'	1.3'	2'	3.5'	499	1.6'	0.8'
8'	4.6'	162	2.1'	1.8'	3'	5.2'	222	2.4'	1.2'
10'	5.8'	104	2.6'	2.2'	4'	6.9'	125	3.2'	1.5'
12'	6.9'	72	3.1'	2.7'	6'	10.4'	55	4.8'	2.3'
15'	8.7'	46	3.9'	3.3'	8'	13.9'	31	6.3'	3.1'

Certified Test Report No. 3765FR, Date: Oct 16, 2008. Computed by LSI Program **Test-Lite**

39W GU6.5 GE Constantcolor CMH Lamp, **Spot** Upper Reflector, Lumen Rating = 3400 lms, Aromat Electronic Ballast

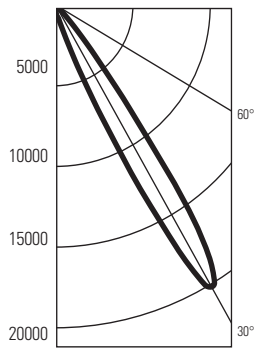

Angle	Wall
0	279
5	554
10	750
15	1227
20	3584
25	11038
30	20162
35	12727
40	3223
45	582
50	82
55	6
60	0
65	0
70	0
75	0
80	0
85	0
90	0

30° Aiming Angle Horizontal Surface					30° Aiming Angle Vertical Surface				
D	C	FC	L	W	D	C	FC	L	W
6'	3.5'	364	1.7'	1.5'	2'	3.5'	630	1.7'	0.8'
8'	4.6'	205	2.3'	1.9'	3'	5.2'	280	2.6'	1.3'
10'	5.8'	131	2.8'	2.4'	4'	6.9'	158	3.5'	1.7'
12'	6.9'	91	3.4'	2.9'	6'	10.4'	70	5.2'	2.5'
15'	8.7'	58	4.2'	3.6'	8'	13.9'	39	7.0'	3.4'

Certified Test Report No. 3945FR, Date: Oct 16, 2008. Computed by LSI Program **Test-Lite**

Job Information Type:

631 Airport Road, Fall River, MA 02720 • (508) 679-8131 • Fax (508) 674-4710
 We reserve the right to change details of design, materials and finish.
 www.lightolier.com © 2011 Philips Group • C0711

PHILIPS
LIGHTOLIER®