

HOLUX GM-305 Personal Navigator

Explorer

User's Guide

Version: 1.03 EI

Date: Mar. 07, 2001

HOLUX Vertrieb Deutschland

o. j. imports, Sascha Schwalbe

Alt-Gatow 33 b, 14089 Berlin

Telefon: 030-36 35 362 Fax: 030-364 00 722

E-Mail: info@holux-gps.de Web: www.holux-gps.de

All Right Reserved

Thank You!

Thank you for choosing HOLUX **Explorer** Handheld GPS as your personal navigator. We hope it will be useful to you for a long time.

Warranty

This **Explorer** is warranted to be free from defects in material and functions for one year from the date of purchase. Any failure of this product within this period under normal operation will be repaired at no charge to you. Please refer to the Warranty Card in the package.

HOLUX Technology, Inc. is a professional consumer GPS (Global Positioning System) products provider. We started research and development of GPS and RF products in 1994. Our goal is continuously to provide people with items that make difficult tasks easier. We hope everyone in the world shares our achievement.

If you have questions about the operation, function or design of this unit, do please contact us at any time.

Holux Vertrieb Deutschland

E-Mail: info@holux-gps.de

Web: www.holux-gps.de

Table of Contents

Chapter 1	QUICK REFERENCE	4
Chapter 2	BEFORE OPERATING	7
	I. NAME	7
	II. ALL MODELS	7
	III. OPTIONAL ACCESSORIES	8
	IV. STANDARD PACKAGE	9
	V. CAUTIONS	10
	VI. ACTIVE ANTENNA DISMANTLE & ASSEMBLE	11
Chapter 3	OPERATING DETAIL	12
	I. ON/OFF & BACKLIGHT	12
	II. SIMULATION	13
	III. MAJOR NAVIGATION FUNCTION KEYS	13
Chapter 4	FUNCTION DETAIL IN PAGES	17
	I. SATELLITES PAGE	17
	II. MAP PAGE	18
	III. STATUS PAGE	21
	IV. COMPASS PAGE	21
Chapter 5	SYSTEM MENU	23
	I. WAYPOINT	23
	II. ROUTE	25
	III. TRACK LOGS	28
	IV. POWER SAVING MODE	30
	V. UPLOAD	30
	VI. DOWNLOAD	32
	VII SYSTEM UPGRADE	33
Chapter 6	SPECIFICATION	35
Chapter 7	MANUFACTURING SETTING	37
	I. BASIC SETTING	23
	II. SPECIAL ENGINEERING SETTING	25
Chapter 8	TROUBLE SHOOTING	38
Appendix A	EARTH DATUMS	40

Chapter 1 QUICK REFERENCE

I. CAUTIONS

A. Please select cold start mode under the following situations:

- (i) Initial use.
- (ii) Moving more than 500 km without performing satellite acquiring.
- (iii) Unused for more than one month regardless of looking up map.

B. Environment and antenna position

- (i) Outdoors without shade.
- (ii) Have the built-in antenna paralleled the ground (i.e. the angle between **Explorer** and ground is 30°) and faced up to the sky.

C. Battery

- (i) Remove batteries from the cartridge when not use more than 30 days.
- (ii) Use a certified charger to ensure batteries are full charged when using rechargeable batteries.

D. Program Waypoint and Routes

When complete, you must turn off **Explorer**. Then Waypoint and routes will be saved in the system.

II. ON/OFF

A. On: press “” for 2 seconds.

B. Off: press “” for 2 seconds.

C. Backlight: press “” once to turn on/off backlight when the unit is on.

III. SIMULATION

Satellite page, press “?” , select **Stop Navigation** and press “ ” for power saving when looking up a map or setting up parameters without satellites acquiring. Be sure to return to **Navigation** after parameters set.

IV. COLD START

Satellite page, press “?” , select **Cold Start** and press “ ” to erase obsolete or incorrect satellite data.

V. POWER SAVING MODE

Select **Pw Saving On** in **Main Menu** page and press “ ”. Turn on this function may make batteries last longer up to 30-70% longer but it may reduce the ability of acquiring satellites.

VI. MAJOR NAVIGATION FUNCTION KEYS

A. MENU “?”

The gate key to operate all functions.

B. PAGE “”

(i) Switch among pages of satellite, map, status and compass.

(ii) Press for 2 seconds to change screen orientation, either **horizontal or vertical**.

C. ZOOM IN “” / ZOOM OUT “”

(i) Enlarge/narrow down map scale.

(ii) In map page, press “” for 2 seconds to erase/redisplay the data in the right down corner.

(iii) Also in map page, press “” for 2 seconds to erase/redisplay road lines.

D. ESCAPE “”

(i) The same function as **PAGE** “”, only in reverse order.

(ii) To quit change of field’s data or return to previous page.

E. ENTER (CONFIRM) “”

(i) To confirm operation.

(ii) Press for 2 seconds to **mark a waypoint** in map page.

VII. FURTHER OPERATION

A. Search object

In map page, press “?”,

(i) **GM-305-DT, GM-305-HT**: Go to **Search Object, Select Region, Select A Type** and then **Select A Name**.

(ii) **GM-305-WT**: No back up map, you may search **Waypoint** and **Route** only.

B. Screen Search (For GM-305-D and GM-305-HT only)

In map page, search in current screen page.

C. Show Map Information (For GM-305-D and GM-305-HT only)

In map page, select “**Show MapInfo**” to show details information when cursor touch a road or an interesting point.

D. Shortcut

After picking up a certain spot, select **Shortcut On**, and press “”.

E. Display (For GM-305-DT, GM-305-HT only)

All icons in the map are displayed as requested. Activate **Display** and select all or some.

F. Moving Map

Hold direction key for 8 directions.

G. Measure distance

Show Dist On enables to measure distance between any two points in the map.

H. Map Orientation

In map page, press “?”, you may select map orientation.

(i) **North up**

(ii) **Track up**

I. Adjust time

Go to **Change Time** from the status page for changing to daylight saving time or the real time in the area across more than one time zone.

J. Adjust contrast

Press “◀” or “▶” key in satellite page to adjust contrast.

K. Waypoints

Creating a waypoint: either go to **Waypoints** from **Main Menu** or press “↵” for 2 seconds in map page.

(i) **GM-305-WT**: Various icons available for **Bank, Gas Station, School**,.....etc.

(ii) **GM-305-DT, GM-305-HT**: One icon only.

As long as a waypoint is edited into a route, it is undeletable.

L. Routes

The unit is able to memorize 20 routes, up to 30 waypoints each.

“*” will show at the right side of the route name once a route is set to navigation.

M. Track logs

Select **Track Logs** from **Main Menu**. You may set intervals by time or distance.

N. Optional Datum

In satellite page, 219 built-in datums for your options.

O. NMEA 0183 Output

In satellite page, you may use **Explorer** as a ordinary GPS receiver linking to other navigation system.

XIII. UPLOAD

Through serial cable, **you may upload Waypoint & Route or Track logs to PC**. Select **Upload** from **Main Menu** to transfer the **Waypoint&Route** or **Track logs** data from your **Explorer** to PC. The data communication baud rate is 57,600bps.

IX. DOWNLOAD

Select **Download** from **Main Menu** to store new **Map, Waypoint&Route, Tracking Logs** or **Font** in the system memory.

X. SYSTEM UPGRADING

When new HOLUX OS released, you may upgrade your unit by this function.

Chapter 2 BEFORE OPERATING

I. NAMES

A. Front

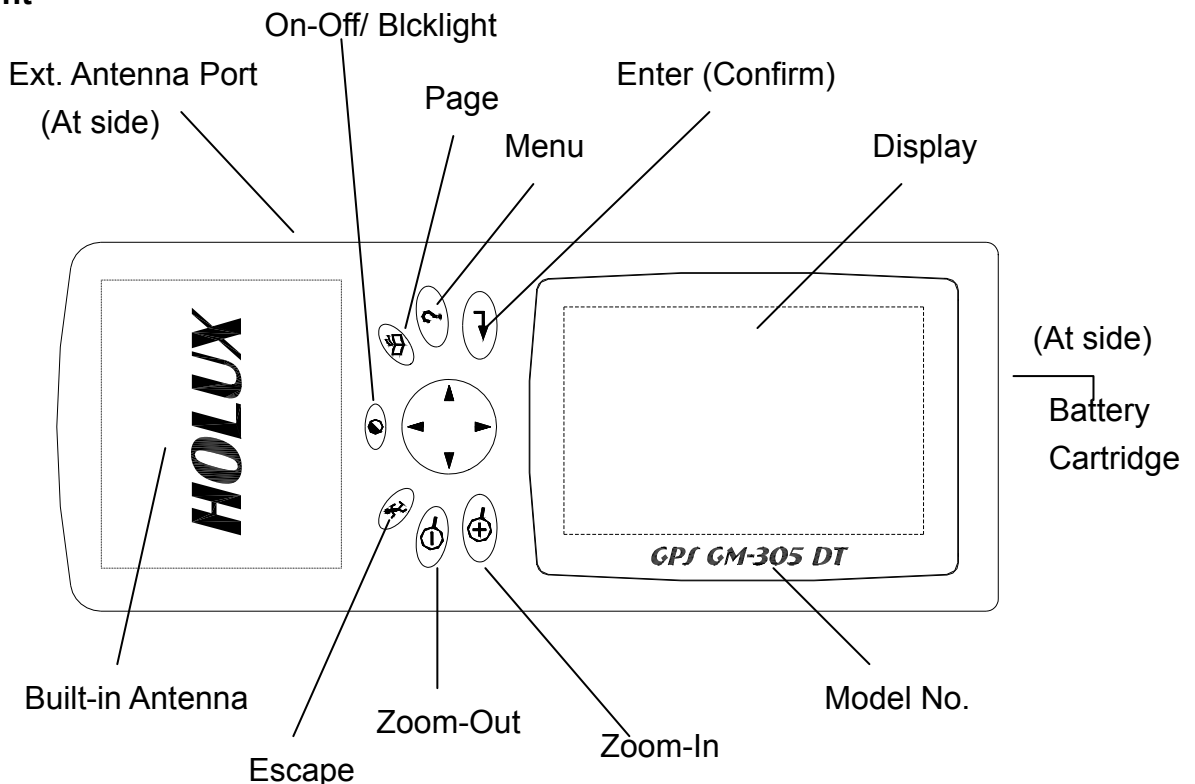

B. Back

Serial Port for data communication (Under rubber cover).

II. ALL MODELS

A. GM-305-WT

With track recording, waypoints and routes functions, special designed for outdoors use wherever in the open field, on the water or when exploring. You may preprogram your route, input waypoint or set track recouiding **ON** to void getting lost. You may also upload your track logs to computer, e-mail it to your fellows for them to trace you or to share with you the interesting places you have been.

B. GM-305-DT

In additional to GM-305-WT, there is a 2-MB built-in memory for map of cities, inter-city roads or recreation area.

C. GM-305-HT

In additional to GM-305-WT, there is an 8-MB built-in memory for map downloading. You may download any interesting places available in the map CD supplied by your local distributor or HOLUX Web Site.

III. OPTIONAL ACCESSORIES

A. Single Item

(i) Explorer Holder (A-30501)

When using the unit in a car, stick the holder on the dashboard with enclosed 3M adhesive pad. you may have the unit held with the antenna facing up to the sky for better signal receiving and reading.

(ii) Data Cable (A-30502)

To up load / down load map, data or to upgrade system.

(iii) Active Antenna

When using **Explorer** in a RV car, truck or bus, connect an extensional active antenna to get better satellite signals. The windshields which are heavily tinted may interfere with signal reception. An active antenna then becomes essential.

A-30503 w/2-M cable

A-30503 w/5-M cable

A-30503S w/0.5-M cable

(iv) Extension Antenna Holder (A-30503-00)

Hold the active antenna to have it face up to the sky.

(v) Extension Cable

For extending the reach of active antenna.

A-30504-01: 1 M cable

A-30504-02: 2 M cable

A-30504-05: 5 M cable

(vi) Hanging Strip Set (A-30505)

150 and 450 mm each

(vii) Carrying Bag (A-30506)

With ring for hanging at waist or on neck.

(viii) Antenna Supporting Rod

For supporting extensional antenna when biking or mountaineering.

A-30507-00: Universal connector for adjusting antenna facing up to the sky.

A-30507-01: 100 mm.

A-30507-02: 200 mm.

A-30507-05: 500 mm.

(ix) Clip Set (A-30508)

Use with A-30507 to grip something to support extensional antenna.

(x) Holding Strip (A-30509)

For holding **Explorer** on the frame of bike or motorcycle.

(xi) Holding Bracket (A-30510)

To hold **Explorer** standing on frame of bike or motorcycle.

(xii) Antenna Bracket (A-30511)

For holding antenna rod on bike or motorcycle.

(xiii) Travelling Bag (A-30512)

To receive all accessories and main unit for travelling or storage.

(xiv) Antenna Rod Supporting Strip (A-30513)

For holding antenna rod to support A-30503 when mountaineering or hiking.

(xv) Optional Map

Mountaineering map, sea map, recreation area map or street map.

(xvi) Battery Charger (A-100B99)

The battery charger is certified and packed with 4 AA batteries of 1,300 mAh nickel-metal hydride rechargeable.

A-100B99: 110V plug

A-100B99EU: 230V European plug

A-100B99AU: Australian plug

(xvii) Rechargeable Battery

A-100B13: 2 AA rechargeable batteries with 1,300 mAh nickel-metal hydride.

A-100B17: 2 AA rechargeable batteries with 1,700 mAh nickel-metal hydride.

B. ACCESSORY KIT (K-3051)

Special designed for mountaineering and biking. The kit includes:

- (i) 1 x A-30503 Active antenna with 2-m cable.
- (ii) 1 x A-30503-00 Active antenna holder.
- (iii) 1 x A-30505 Hanging strip.
- (iv) 1 x A-30506 Carrying bag.
- (v) 1 x A-30507-00 Universal connector.
 - 1 x A-30507-01 Antenna supporting rod.
 - 3 x A-30507-02 Antenna supporting rod.
- (vi) 1 x A-30508 Clip set.
- (vii) 1 x A-30509 Holding strip.
- (viii) 1 x A-30510 Holding bracket.
- (ix) 1 x A-30511 Antenna bracket
- (x) 1 x A-30512 Travelling bag.
- (xi) 1 x A-30513 Antenna rod supporter.

IV. STANDARD PACKAGE**A. Single Package****(i) Main Unit (GM-305)**

Please remove the plastic covering on the display to get a clear screen.

(ii) Manual

Packed with a quick reference card and warranty card.

B. Full Package (GM-305-??) (?? for different language version)

Details please refer above Optional Accessories or single package.

(i) Main Unit (GM-305)**(ii) Manual**

Packed with a quick reference card and warranty card.

(iii) A-30501 Holder**(v) A-30502** Data Cable**(vi) M-305-??** Map CD (?? varies in different countries)

Your country map CD. You may download any or some areas to the unit.

(vii) 4 AA NI-MH rechargeable batteries, 1300mAH (2 x A-100B13)**V. CAUTIONS****A. Cold Star**

Please select **Cold Start** under the following situations:

- (i) Initial use.
- (ii) Moving more than 500 km without using in the way.
- (iii) Unused for more than one month regardless of looking up map.

B. Antenna Position

Please keep in mind the following principles whenever you use the unit to receive satellite signals.

- (i) The GPS navigator relies on the satellite signals, which are not amplified or transmitted by base stations on earth. Contrary to GSM on cellular phones, the signals is weak so please use the **Explorer** outdoors with a clear view to the sky.
- (ii) The built-in antenna should be parallel to the ground and face to the sky. The best angle to the ground is 30°.as Fig. 2-4-1.

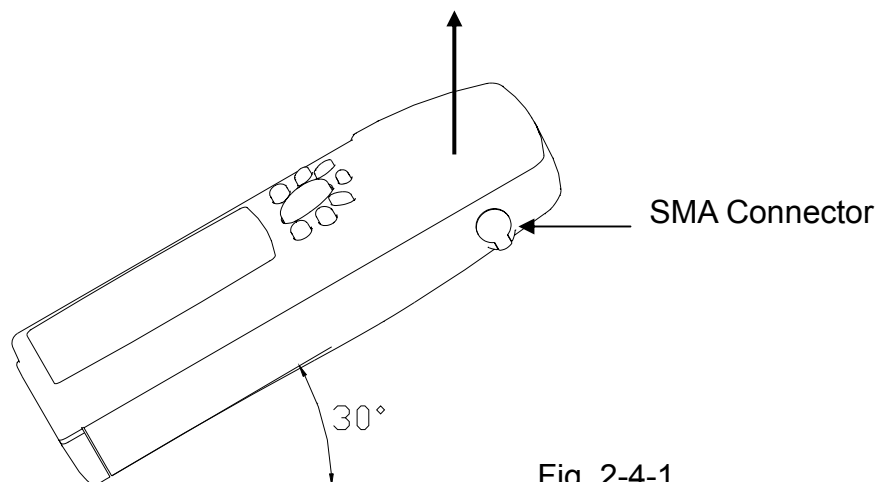

Fig. 2-4-1

C. Battery

- (i) Use 4 AA alkaline or rechargeable batteries.

- (ii) Use a certified charger to ensure batteries are full charged.
- (iii) **Remove batteries from the cartridge when not use more than 30 days.**

VI. EXTENSION ANTENNA ASSEMBLE & DISASSEMBLE

- A. Remove rubber cover at right top side as Fig.2-4-1.
- B. Connect active antenna with **SMA** connector to the unit.

Chapter 3 OPERATING DETAILS

The Explorer Handheld GPS is a miniature computer, composed of a CPU, memory IC and operation system (OS), called *HOLUX OS*. It is designed to receive the satellite signals once every 100 milli-second, i.e. 10 times per second, and to calculate all the retrieved data in the CPU. In that case, there will be some delay after you press a button. Also its processing speed is not as quick as a desktop computer for the sake of low power consumption.

I. ON/OFF & BACKLIGHT

A. On

Press and hold “” for 2 seconds to turn on the unit as Fig. 3-1-1. It will switch to acquiring satellites page and search satellite signals automatically in 3 seconds as Fig. 3-1-2. Once a satellite is acquired, the signal bar will appear. If the satellite signal fixed, the bar will turn black. The stronger the signal is, the longer the bar is. After more than 3 satellites are acquired and fixed, your position is identified and the display goes to the map page as Fig. 3-1-3 for GM-305-DT and GM-305-HT or a “▲” only in the map for GM-305-WT.

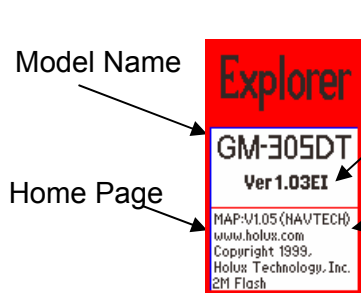

Fig. 3-1-1

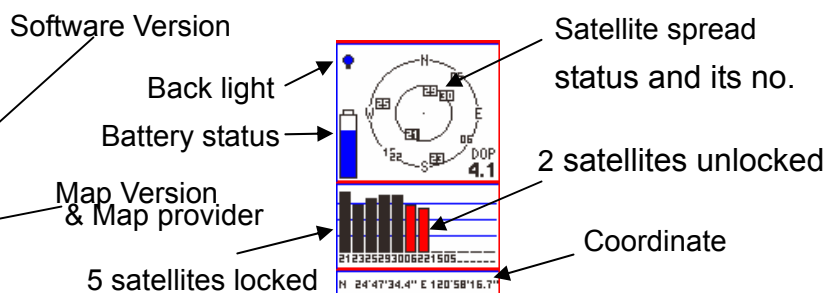

Fig. 3-1-2

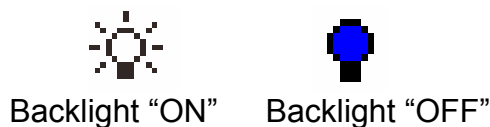

Fig. 3-1-4

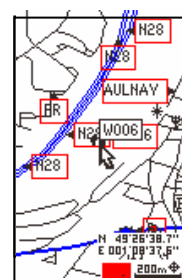



Fig. 3-1-3

B. Off

Press and hold “” for 2 seconds.

C. Backlight

press “” to turn on/off backlight as Fig. 3-1-4 when the unit is on.

Note: The following message will show up when Explorer can not get position identified for 10 minutes continuously: This message may show in any page.

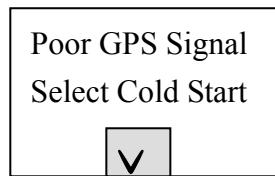

In fact, You do not need to operate **Cold Start**. But you must improve satellite-acquiring environment unless incorrect satellite data stored in the system.

II. SIMULATION

This function is for looking up a map or setting up waypoints and routes regardless of acquiring satellite signals. It may save power and respond quicker.

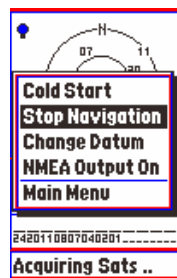

Fig 3-2-1

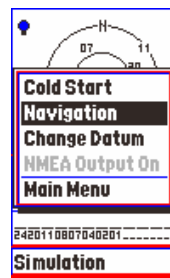

Fig 3-2-2

- A. Press “?”.
- B. Select **Stop Navigation** as Fig. 3-2-1, and press “←”.
- C. Be sure to switch to **Navigation** when you use navigation on the way. Otherwise, you will never get your position identified.
 - (i) Press “?”
 - (ii) Select **Navigation** as Fig. 3-2-2, and press “←”.

III. MAJOR NAVIGATION FUNCTION KEYS

A. MENU “?”

It is the initial key to all kinds of functions. Details will be described in later chapters.

B. PAGE “📖”

- (i) Press to switch pages among satellite as Fig. 3-1-2, map as Fig. 3-1-3, status as Fig. 3-3-1 and compass as Fig. 3-3-3. There are a central mark “▲” and scale only in map page for GM-305-CT.

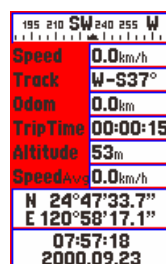

Fig. 3-3-1

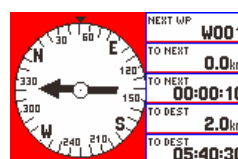

Fig. 3-3-2



Fig. 3-3-3

(ii) Press and hold "📖" for 2 seconds to change screen orientation, **horizontal** or **vertical** as Fig. 3-3-2 and Fig. 3-3-3.

(iii) Satellite Page

In this page, you may see battery level, backlight and what & how many satellites are acquired. Once a satellite is acquired and fixed, the signal bar will turn dark. Moreover, strength of satellite signal will be told by length of signal bar as Fig. 3-1-2. Press direction key "◀" or "▶" to enter and adjust the contrast of screen as Fig. 3-3-4, "◀" for lighter and "▶" for darker, Press "↶" to confirm or "👤" to ignore.

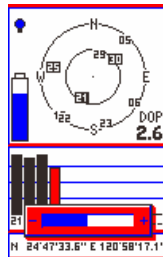

Fig. 3-3-4

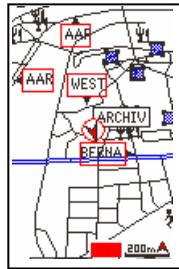

Fig. 3-3-5

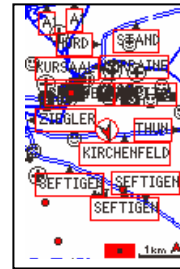

Fig. 3-3-6

(iv) Map Page

(a) You may move map with direction keys, or **ZOOM-IN / ZOOM-OUT** the map.

(b) **The cursor arrow is full when your position is identified, otherwise it will be hollow.**

(v) Status Page

This page gives the following information: Speed, Track, Odom, Trip Time, Altitude, Average Speed, Latitude, Longitude, Time and Date as Fig. 3-3-7.



Fig. 3-3-7



Fig. 3-3-8

Moving Direction

(vi) Compass Page

You may see your moving direction, next waypoint, distance & time to next waypoint and distance & time to destination. **If you do not input route in the system, the arrow will not show and all value fields will be 0.** The arrow in the compass points to the direction to next waypoint and your proceeding direction as Fig. 3-3-8.

C. ZOOM IN/OUT "⊕" \ "⊖"

(i) Press "⊕" \ "⊖" to switch map scale from 100m, 200m, 500m, 1km, 2km, 5km, 10km,

20km, 50km, 100km, 200km, 500km, 12 levels in total.

- (ii) Press and hold “⊕” for 2 seconds to display/clear scale, map mode and area size in right down corner.
- (iii) Press and hold “⊖” for 2 seconds to display/clear roads to check routes or track logs.
(For GM-305-DT and GM-305-HT only)
- (iv) When zooming in/out map, a black dot in the right down square changes size and related position accordingly as Fig. 3-3-9. The dot denotes the map displayed in the screen and the square denotes the whole map. (For GM-305-DT and GM-305-HT only)

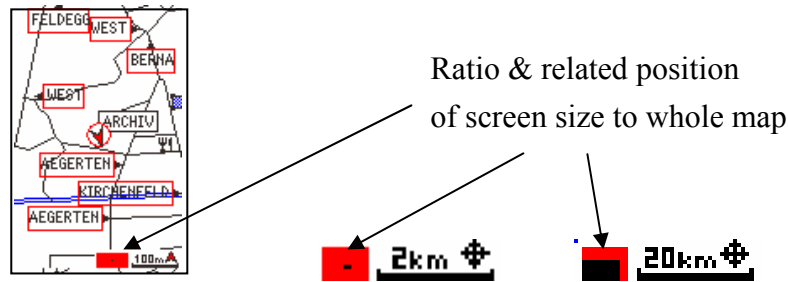

Fig. 3-3-9

D. ESCAPE “↶”

- (i) The same function as “↷” in reverse order.
- (ii) To ignore a selection in the menu.

E. ENTER “↵”

- (i) Press and hold for 2 seconds to create a waypoint at the cursor position in map page.
Detail describes in page 23 **Method 2**.
- (ii) To change operating mode, either navigation “▲” or view map “⊕” in map page. The symbol at right down corner shows in navigation mode as Fig. 3-3-10, and in view map mode as Fig. 3-3-11.

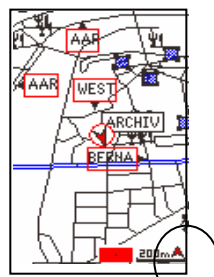

Fig. 3-3-10

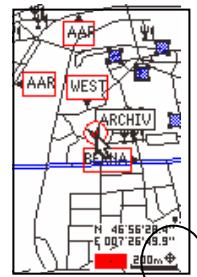

Fig. 3-3-11

F. Moving map

There are total 8 directions for direction function keys. Press “↶” to switch the symbols

“▲”

and “⊕” at the right down corner.

- (i) In view map mode, the screen shows a cursor “↷”, an arrow “▲” and data about latitude and longitude appearing in right down corner. If position is fixed, “▲” is your present

position. Before position fixed, “▲” is your last position or the center position when downloading map in last operation. The “▲” is fixed and can't be moved.

- (a) Click any direction key once to scroll map 1/2 page.
 - (b) Hold a direction key to move cursor “↖”. When the cursor goes to the edge of screen, the map still moves accordingly until you release the key.
 - (c) The cursor stops at any position. If you change to other pages, it will still be at the same position as in last map page.
- (ii) In navigation mode, there is only a symbol “▲” as Fig. 3-3-11.
- (a) Hold a direction key for a second to make cursor “↖” appear as well as latitude and longitude. You may move the map by doing the former action.
 - (b) Press “↖” to make the cursor “↖” disappear and return to navigation mode. You will see “▲” shows in the center of map. If you got position identified, it is your real position.
- (iii) When moving the cursor to touch an interest spoint or road, its name will show.

Chapter 4 FUNCTION DETAIL IN PAGES

I. SATELLITE PAGE

A. Adjust Contrast

- (i) Press direction key “◀” or “▶” to adjust the contrast of screen as Fig. 3-3-4, “◀” for lighter and “▶” for darker.
- (ii) Press “←” to confirm or “⌫” to escape.

B. Cold Start

This function is to clear obsolete or incorrect satellite data stored in its memory. If you cannot receive satellite signals to identify your position after turning on for a few minutes, you may turn off and turn on again. The obsolete data and uneven distribution of satellites may cause poor signal receiving. So when doing this action for two or three times but fail, and if you are not under shade in the forest, close to a high building or at a side of a sharp mountain, i.e. you do have a clear view to the sky, please select **Cold Start** and press “←” to confirm. It may help you got position identified quicker.

C. Simulation

Please refer to page 13 as Fig. 3-2-1 and Fig. 3-2-2.

D. Change Datum

Explorer provides 219 map datums. You may change it. Detailed datums please refer to **Appendix A**. After turned on **Explorer**, the 1st highlighted datum in the “Select A Datum” page is the current datum used in the unit.

- (i) Press “?” , select **change datum** as Fig. 4-1-1 and press “←” as Fig. 4-1-2.
- (ii) Press “?” to start searching a datum by alphabet sequence as Fig. 4-1-3.

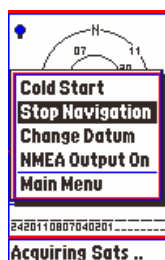

Fig. 4-1-1



Fig. 4-1-2

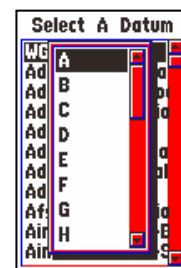

Fig. 4-1-3

Note: If you turn on the unit, select **Change Datum** and move marked datum without pressing “←” , when you switch to other page then switch back to satellite page and select **Change Datum**, the hightlighted datum is not the one used in the system because you did not change the datum in above actions.

E. NMEA Output

The **Explorer** provides NMEA 0183 output to enable you to use this unit as an ordinary GPS receiver for linking to a notebook PC or other devices for navigation or other applications.

- (i) Press “?”
- (ii) Select **NMEA output On/Off** and press “←”

You may output all satellite positioning information through the serial port cable A-30502. The default of output is:

- (i) **Update rate:** once per second.
- (ii) **Baud rate:** 4,800 bps.

Note: (a) When **NMEA OUTPUT ON**, the setting of **Explorer** changes as follows automatically:

POWER SAVING OFF
UPLOAD and DOWNLOAD OFF

- (b) When **NMEA OUTPUT OFF**, the setting of **Explorer** returns to that before NMEA OUTPUT ON.
- (c) When **Explorer** outputs the satellite information, the reaction speed of the unit will slow down significantly.
- (d) In simulation mode, the **NMEA OUTPUT ON** is grayed.

F. Main Menu

Please refer to page 23 as Fig. 5-1-1.

II. MAP PAGE

---- For **GM-305-DT & GM-305-HT** ----

Press “?”, options are as follows:

Search Object, Screen Search, Show MapInfo, Shortcut On/Off, Display, High/Low Speed, Show Dist On/Off, North/Track up and Main Menu as Fig. 4-2-1.



Fig. 4-2-1

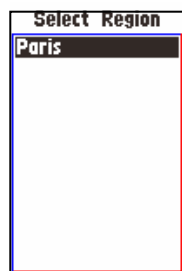

Fig. 4-2-2



Fig. 4-2-3

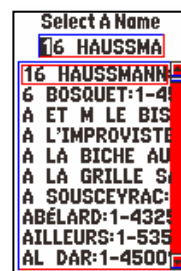

Fig. 4-2-4



Fig. 4-2-5

A. Search Object (For **GM-305-DT & GM-305-HT**)

- (i) Select **Search Object**, and press “←”.
- (ii) Move marked field to select a region as Fig. 4-2-2 and press “←”.
- (iii) Move marked field to select a type, e.g. **City**, as Fig. 4-2-3 and press “←” as Fig. 4-2-4.
- (iv) Press “?” to move marked field to top level to start searching a City name by alphabet sequence as Fig. 4-2-4. Press “▲” or “▼” to change character, press “◀” or “▶” to change column. You may select up to 4 columns. When you change the alphabet, the City in the screen will change accordingly.
- (v) Press “←” to move marked field back to lower level to select a **City**.
- (vi) Press “←” to show detailed **City** information. There are district, city, country, direction/distance from current position and phone number (for an interesting point only) shown in the screen as Fig. 4-2-5.
- (vii) Move marked field to “√”, press “←” to show selected **City** in the map or press “⌂” to ignore and press “⌂” again and again to former map page.

Note: To search a waypoint, you may go into a region and press “←”. Then move marked field to **Waypoint**.

---- For **GM-305-WT** ----

Press “?”, options are as follows:

Search Object, Shortcut On/Off, High/Low Speed, Show Dist On/Off, North/Track up and Main Menu as Fig. 4-2-1A.



Fig. 4-2-1A

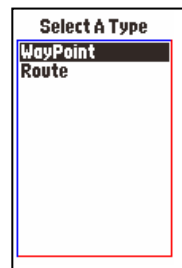

Fig. 4-2-2A

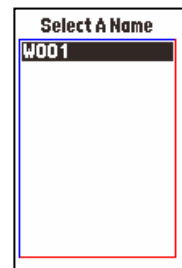

Fig. 4-2-3A

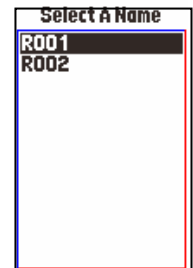

Fig. 4-2-4A

A-1. Search Object (For **GM-305-W**)

- (i) Select **Search Object**, as Fig. 4-2-1A and press “←” as Fig. 4-2-2A.
- (ii) Move marked field to select Waypoint or Route and press “←” as Fig. 4-2-3A or 4-2-4A.

B. Screen Search (For GM-305-DT and GM-305-HT only)

- (i) Select **Screen Search** and press “←” to show all roads and interest points in the current map page.
- (ii) Move marked field to select an item, e.g. a road and press “←”. The selected object will show in the map.
- (iii) When moving marked field, you may press “▲” or “▼” once to next item or press and

hold to roll the page.

C. Show Map Information (For GM-305-DT and GM-305-HT only)

- (i) Move cursor to touch a road or an interesting point, then press “?”.
- (ii) Move marked field to **Show MapInfo**, press “←” to show map information.
- (iii) When cursor is not touching a road or an interesting point, the **Show MapInfo** will be not active (grayed).

D. Shortest Way

From present position to the selected object directly is the shortcut as Fig. 4-2-6.

- (i) Select an object by **Search Object** or **Screen Search** function.
- (ii) Select **Shortcut On** and press “←”. There will be a line between the two positions. When you move, your end of the line will move in accordingly.
- (iii) Press “←” to return to “▲” navigation mode and get your real position from view map mode.
- (iv) Select **Shortcut Off** and press “←” to withdraw the short cut line.



Fig.4-2-6

E. Display (For GM-305-CT and GM-305-DT only)



Fig. 4-2-7



Fig. 4-2-8



Fig. 4-2-9



Fig. 4-2-10



Fig. 4-2-11

- (i) Select **Display** and press “←” as Fig. 4-2-7. Follow Step (a) to show/hide individual icons. You may also follow Step (b) to show/hide all icons.
 - (a) Move the cursor to icon you need and press “←”. You may select more than one icon. To erase a selected icon, just move the cursor to the icon to be erased and press “←”.
 - (b) Press “?” and press “←” to show/hide all icons.
- (ii) Move the cursor to “▼” and press “←” to return to the map page.

When setting, you may follow steps below for more information and further options:

- (i) Move the cursor to ↓ and press “←” to check icons as Fig. 4-2-8. Press “←” to confirm

- selection and return to the map Page or press "↵" to ignore and return to the former page.
- (ii) Move the cursor to ? and press "←" to check out the meaning of every icon as Fig. 4-2-9, 4-2-10 and 4-2-11. Switch pages by selecting ↓ and ↑ and press "←". You may press "↵" to ignore and return to the former page.

F. Cursor Speed (For GM-305-DT and GM-305-H only)

Select **Low/High Speed** and press "←" to select suitable cursor speed.

G. Distance Measuring

- (i) Select **Show Dist On** and press "←".
- (ii) Move the cursor to the beginning point and press "←".
- (iii) Move the cursor to the second point and press "←". The distance will be marked in the middle of the line between the two points as Fig.4-2-12. You may repeat to measure the distance to the next point and up to 5 spans can be shown.
- (iv) Press "?", select **Show Dist Off** and press "←" to end distance measuring and erase all the marks.



Fig. 4-2-12

- P.S.** (i) You may measure distance in view map mode or navigation mode respectively.
- (ii) When you switch to other pages, all distance measurement and marks will be erased automatically. And the system will change to **show distance Off** as well.

H. Map Orientation

Select **North / Track up** and press "←" to define map orientation.

- (i) **North up:** To display the map by North fixed at top of the screen.
- (ii) **Track up:** To rotate the map automatically to keep your orientation at top of the screen. There will be a "North" indicator at the right top corner in this mode. The black side of the indicator pointing to north.

H. Main Menu

Please refer to page 23 as Fig. 5-1-1.

III. STATUS PAGE

In this page, your moving Direction, Speed, Distance, Averaged Speed and Trip Time will be told as well as the data about Altitude, Latitude, Longitude, Time and Date in your current position as Fig. 4-3-1. Press "?" to get **Change Time** and **Main Menu** for options as Fig. 4-3-2.



Fig.4-3-1

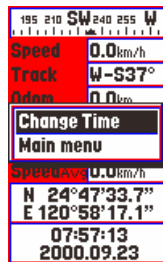

Fig.4-3-2



Fig.4-3-3



Fig.4-3-4

A. Time Adjustment

- (i) Prior to changing the time, make sure of the actual difference between the time stored in the **Explorer** and your local time. You only need to change the hours. The date and minutes can't be changed.
- (ii) Select **Change Time** and press “←” as Fig. 4-3-3.
- (iii) Move the marked field to **Minus/Plus** and press “←” as Fig.4-3-4, 4-3-5.
- (iv) Move the marked field to **Hour** and press “←”.
- (v) Press direction keys, “◀” or “▶” to mark one of the two figures.
- (vi) Press direction keys, “▲” or “▼” to adjust time and press “←”.
- (vii) Move marked field to “▼” and press “←”.
- (viii) Let the **Explorer** position fixed to get correct **time**. If the **Explorer** is position fixed within one month, the **Explorer** should already show the correct **time**.

B. Main Menu

Please refer to page 23 as Fig. 5-1-1.

IV. COMPASS PAGE

Your moving direction is displayed in this page as well as the name, distance and time to next waypoint and destination respectively as Fig. 3-3-8 in gage 14.

Time to destination = (distance) / (average speed)

The moving direction is as “▼” pointing at the top outside the compass. There will be an arrow “↓” in the compass pointing to the direction to next waypoint while route navigation function on. Please refer to page 25 to create routes.

Press “?” to go to **Main Menu**. Please refer to page 22 as Fig. 5-1-1.

Chapter 5 SYSTEM MENU

Press “?” in any page to select **Main Menu** as Fig.5-1-1 (for GM-305-DT, GM-305-HT only) and press “←”. There are **Waypoints, Routes, Track Logs, Pw Savings On/Off** and **UpLoad** and **DownpLoad** for options as Fig. 5-1-2.

I. WAYPOINTS

Explorer can hold up to 500 waypoints.



Fig. 5-1-1

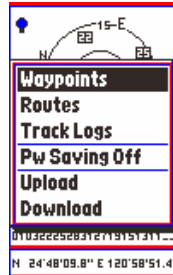

Fig. 5-1-2

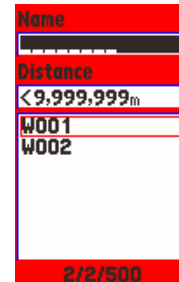

Fig. 5-1-3

Select **Waypoints** and press “←”. You may see name, distance, waypoints and a set of figures, **2/2/500** at the bottom as Fig.5-1-3. The first digit is the number of waypoints meeting the display criteria. The second one is the sum of waypoints which you have created in the unit. The last one is the maximum of waypoints which may be used in the system.

A. Criteria

The name and distance are the criteria to show waypoints in the column. To change the criteria do as follows:

(i) Name

- (a) Move the marked field to **Name** and press “←” to enter up to 8 characters, numbers or symbols. The data of waypoints in the column will change accordingly. “-” means ignoring all criteria and all waypoints will show.

e.g. -----: shows all waypoints,

W ----: shows the waypoints with **W** initial, and

---s----: shows the waypoints with **s** in the fourth column and ignoring other columns.

- (b) Press direction keys “▲” or “▼” to change data, “◀” or “▶” to change column. Press “←” setup is complete.

(ii) Distance

- (a) Move the marked field to **Distance** and press “←” to enter a larger “>”/smaller “<” mark followed by any digit within 9,999,999m. The data in the column will change accordingly.

- (b) Press direction keys “▲” and “▼” to change data, “◀” or “▶” to change column.
- (c) Press “←” when set up complete.

The functions of direction keys:

“▲”: Select alphabet, number or symbol. The order is ...D, C, B, A,

“▼”: Select alphabet, number or symbol. The order isA, B, C.....

“◀” and “▶””: change column.

The order for all alphabets, numbers and symbols are ”A B C...a b c.... 0 1 29 . : ; ! ? + - = * / # “()”. There are 52 alphabets, 10 numbers and 14 symbols.

B. Create New Waypoints

Press “?” to get **New**, **Edit**, **Delete** and **Delete All** displayed as Fig. 5-1-4.



Fig. 5-1-4

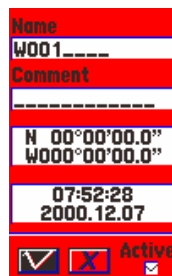

Fig. 5-1-5
(GM-305-DT/HT)



Fig. 5-1-5A
(GM-305-W)

Display On/Off switch



Fig. 5-1-6

Method 1:

Select **New** and press “←” to turn the page as Fig. 5-1-5 for GM-305-DT & GM-305-HT,

as

Fig. 5-1-5A for GM-305-WT. You may get a default waypoint name starting from W001. All the active fields are changeable by demand.

- (i) **Name:** Move the marked field to **Name** and press “←” to edit.
- (ii) **Comment:** Move the marked field to **Comment** and press “←” to edit.
- (iii) **Coordinate, Date:** Repeat the actions above to edit latitudes (N/S), longitude (E/W), time and date.
- (iv) **Waypoint** (for **GM-305-WT** only): Repeat the actions above to select the mark you need. There are 28 different type of marks for your options as fig. 4-2-9, 4-2-10 and 4-2-11 in page 19.
- (v) **Show:** You may move the marked field to **Active** and press “←” to have the waypoint shown (or not) in the map as Fig. 5-1-6.
- (vi) **OK:** Move the marked field to and press “←” to complete your new entry.
- (vii) Press “↶” to go back to former page.

Method 2:

- (i) Move the cursor “↖” to the objective in map page.
- (ii) Press and hold “←” for one second to turn the page as Fig. 5-1-5.
- (iii) Follow the steps as Method 1.
- (iv) The time and date is your present one.

Note: If you have not changed the coordinate, the waypoint you created is:

- (a) Method 1: At present address at “▲”.
- (b) Method 2: At the cursor “↖” in the map. If there is no cursor in the map, it is at “▲”.

C. Edit Waypoints

- (i) Go back to previous page or go to **Waypoints** from main menu as Fig. 5-1-3.
- (ii) Move the marked field to the list of waypoints and press “←”.
- (iii) Select the waypoint to be edited, press “←”.
- (iv) Press “?”, select **Edit** and press “←” as Fig. 5-1-5.
- (v) Go step by step as creating a new waypoint.

D. Delete Waypoints

- (i) Go back to previous page or go to **Waypoints** from main menu as Fig. 5-1-3.
- (ii) Move the marked field to the list of waypoints and press “←”.
- (iii) Select the waypoint to be deleted, press “←”.
- (iv) Press “?”, Select **Delete** and press “←”.
- (v) Press “↩” to go back to former page.

E. Delete All

- (i) Go back to previous page or go to **Waypoints** from main menu as Fig. 5-1-3.
- (ii) Press “?”, select **Delete All** and press “←”. All waypoints not edited into a route will be deleted.

- Note!**
- (a) The waypoint is undeletable once it is edited into a route.
 - (b) Once a Waypoint is edited into a route, “*” will show at right side of the name of the waypoint.
 - (c) The name of deleted waypoint will not appear again in the system unless you edit a new one and name it again.
 - (d) When complete, you must turn off **Explorer**. Then all waypoints you created will be saved in the system.

II. ROUTES

The **Explorer** can hold 20 routes, 30 waypoints each.

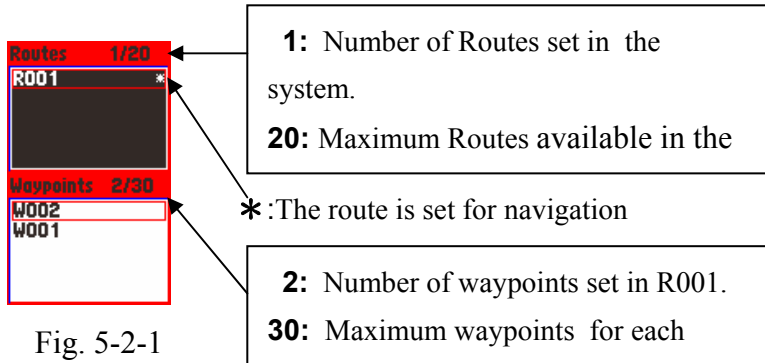

Fig. 5-2-1

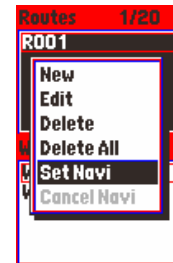

Fig. 5-2-2

A. Route Page

- (i) Select **Routes** from **Main Menu** and press “←” as Fig. 5-2-1. The created routes are displayed in routes column. The definitions of figures outside the routes and waypoints columns are explained as Fig.5-2-1.
- (ii) Press “?” to move into further options as Fig.5-2-2, **New, Edit, Delete, Delete All, Set Navi** and **Cancel Navi**. Only **New** is active when you have not built any route yet.

B. Create New Routes

- (i) Select **New** and press “←” as Fig.5-2-3.
- (ii) The default in the system begins with R001. Press direction keys to rename. Please refer to the section **WAYPOINTS** in page 22/23.

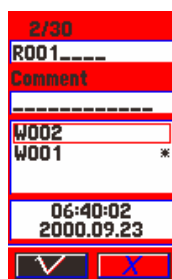

Fig. 5-2-3



Fig. 5-2-4



Fig. 5-2-5

- (iii) Press “?”, options as follows:

Append WP, Insert WP, Delete WP, Delete All and **Invert WP** as Fig. 5-2-4.

(a) Append Waypoints

Add a new waypoint in a route.

- (1) Select **Append WP** and press “←” as Fig.5-2-5. You may set the criteria of waypoints to minimize the quantity of the waypoints to be selected. Please refer to **Criteria of Waypoints** in page 22.

- (2) Move the marked field to the list of waypoints and press “←”.
- (3) Select a waypoint and press “←”.
- (4) Move marked field to “√” and press “←”. The waypoint is now selected into

the

route.

- (5) To append second waypoint, just press “?” and duplicate the above steps (1) – (4).
- (6) Move marked field to “√” and press “←” to complete creating a new route..
- (7) Press “↩” to go back to former page.

Note! In Waypoint, the name and distance field defines the displaying column. Please refer to P. 22 Waypoint A. Criteria step by step.

e.g. -----: means to display all waypoints;

w-----: means display the entire ‘w’ initial waypoints.

---**s**---: shows the waypoints with **s** in the fourth column and ignoring other columns.

(b) **Insert Waypoints**

Insert a waypoint before an existing waypoint.

- (1) Move the marked field to the waypoint column in Fig. 5-2-3 and press “←”.
- (2) Select a waypoint, press “←”.
- (3) Press “?”, select **Insert WP** and press “←”.
- (4) Move the marked field to the list of waypoints and press “←”.
- (5) Select a waypoint and press “←”.
- (6) Move marked field to “√” and press “←”. The waypoint is now selected into

the

route.

- (7) To insert 2nd waypoint before the one you just inserted, follow steps (3) – (6) again.
- (8) To insert a new waypoint before another waypoint, follow steps (1) - (6) again.
- (9) Press “↩” when complete.

(c) **Delete Waypoints**

Delete a waypoint from a route

- (1) Move the marked field to the waypoint column in Fig. 5-2-3 and press “←”.
- (2) Select the waypoint to be deleted, press “←”.
- (3) Press “?”, select **Delete WP** and press “←”.
- (4) Move marked field to “√” and press “←” to complete the deletion.
- (5) Press “↩” when complete.

C. Edit Routes

- (i) Go back to the page as Fig. 5-2-1 or select from **Main Menu**.
- (ii) Select the route to be edited and press “←” as Fig. 5-2-3.

- (iii) Please refer to **Waypoints** in page 22 for editing.
- (iv) When complete, move marked field to “√” and press “←” to return to previous page.
Then press “↩” to return to former page.

D. Delete a Route

- (i) Go to the page as Fig. 5-2-1 or select from **Main MENU**.
- (ii) Select the route to be deleted.
- (iii) Press “?”.
- (iv) Select **Delete** and press “←” to erase the route.
- (v) Press “↩” when complete.

Note! (a) The route can not be deleted if a navigation route existing. Be sure to cancel navigation before deleting.

- (b) The name of deleted waypoint and route will not appear again in the system unless you edit it and name it again.

E. Delete All Routes

The same as above, select **Delete All**.

F. Set Navigation

- (i) Go to the page as Fig. 5-2-1 or select from **Main MENU**.
- (ii) Select the route to be navigated.
- (iii) Press “?”, Select **Set Navi** and press “←”. A mark of “*” will show at right side of the route.
- (iv) Press “↩” to return to the former page. The selected route will link all waypoints created and show in the map screen.

G. Cancel Navigation

- (i) Go to the page as Fig. 5-2-1 or select from **Main MENU**.
- (ii) Press “?”, Select **Cancel Navi** and press “←”.

III. TRACK LOGS

Explorer can hold up to 6 tracks, 5 in back up and 1 in use.

Select **Track Logs** from **Main Menu** and press “←” to the page as follows:

Off: Stop recording track logs

Fill: Recording Track log until memory full (up to 2,500 points)

Wrap: Endlessly recording Track log.

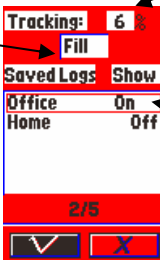

Memory space occupied (by current recording track)

ON: Display Track logs in Map.

Off: No display in map.

2: total track logs saved.

5: total track logs back up available in the system.

Fig. 5-3-1



A. Start to Track

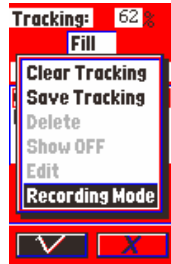

Fig. 5-3-2



Fig. 5-3-3

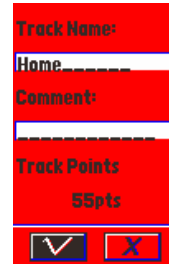
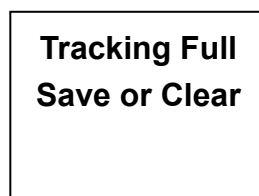

Fig. 5-3-4

- (i) Move marked field to **Off/Fill/Wrap**, press “←”
- (ii) Select **Fill** or **Wrap** and press “←”.
- (iii) Press “?”, select **Recording Mode** as Fig. 5-3-2 and press “←” as Fig. 5-3-3 to set your recording mode. There are two parameters-- time and distance. You may set either one or both as recording criteria.
 - (a) **Distance**
Move the marked field to **Dist Interval** and press “←”. Interval options include 20, 50, 100, 200, 500m, 1, 2 and 5km. You may select one or leave the field “-----“ to ignore the parameter and press “←”.
 - (b) **Time**
Move the marked field to **Time Interval** and press “←”. Interval options includes 1, 2, 5, 10, 20, 30 seconds, 1, 2, 5 and 10 minutes. You may also select one or leave the field “-----“ to ignore the parameter and press “←”.
- (iv) Move the marked field to “√” as Fig. 5-3-3 and press “←”.
- (v) Move the marked field to “√” as Fig. 5-3-1 and press “←”.
- (vi) As soon as the **Explorer** identifies your position, it starts recording track logs. It sets a track log when meeting either parameter. There will be a dotted line between two track logs if they are far from each other.
- (vii) 2,500 track logs are maximum for each tracking log. But the dots in the dotted line mentioned above (vi) are not included in the 2,500 track logs.

Important: If you set recording mode **FILL**, when the **Explorer** records up to 2,500 points, the screen will show:





You are recommended to take following actions:

- (a) Press “←” or “↵” to clear the message.
- (b) Follow the steps in next paragraph to save or clear current track log. Otherwise, the message will show again once you turn on the **Explorer**.

B. Further Operation on Tracking

As Fig. 5-3-1 Press “?”. Options are **Clear Tracking, Save Tracking, Delete, Show Off/On, Edit** and **Recording Mode**.

(i) Clear Tracking

This function erases current track logs in use.

- (a) Select **Clear Tracking** and press “←”.
- (b) Move the marked field to “√” as Fig. 5-3-1 and press “←” to return to former page.

(ii) Save Tracking Log

- (a) Select **Save Tracking** and press “←” to save tracking log in use in real Time. The name of track log is changeable on demand.
- (b) Move the marked field to “√” as Fig. 5-3-1 and press “←” to return to former page.

Note: When you save the 6th track log while other 5 track logs already saved in the system, the following message will show up:

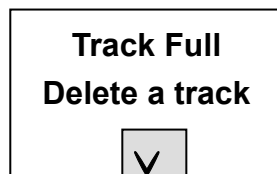

(iii) Delete

Return to the page as Fig. 5-3-1 to do as follows:

- (a) Move the marked field to saved track logs and press “←”.
- (b) Select the tracking log to be deleted and press “←”.
- (c) Press “?”, select **Delete** and press “←” to complete the deletion.
- (d) Move marked field to “√” and press “←” or press “↵” to return to former page.

Note: To execute deletion, it doesn’t matter if the tracking log is **Show ON or OFF**.

(iv) Show On/Off

This function is for display/hide the tracking log. Return to the page as Fig. 5-3-1 to do as follows:

- (a) Move the marked field to saved track logs and press “←”.
- (b) Select the tracking log to be displayed and press “←”.

- (c) Press “?”.
- (d) Select **Show On/Off** and press “←” to display/hide..
- (e) Move the marked field to “√” and press “←” or press “↶” to return to former page.

Note: you may pick up more than one tracking logs to display at the same time.

(v) Edit

Return to the page as Fig. 5-3-1 to do as follows:

- (a) Move the marked field to saved track logs and press “←”.
- (b) Select the tracking log to be edited and press “←”.
- (c) Press “?”.
- (d) Select **Edit** and press “←”. You may see the name and number of the points of this tracking log as Fig. 5-3-4.
- (e) Please follow the instructions as editing waypoints in P.23.
- (f) Move the marked field to “√” and press “←”.

(vi) Recording Mode

Set your parameters to record track logs. Return to the page as Fig. 5-3-1 to do as follows:

- (a) Press “?” , select **Recording Mode** and press “←”.
- (b) Operation details are the same as Start to track in page 26.

IV. Power Saving Mode

A. Power Saving ON

Select **Pw Saving Mode** and press “←”. If the **Explorer** receives satellite signals well, it works in power saving mode automatically. Otherwise it may turn this function off to get better acquisition to satellites. When receiving condition improved, it will return to power saving mode again.

B. Power Saving OFF

Select **Pw Saving Off** and press “←” to have **Explorer** work in continuous mode to have better satellite acquisition when outsourcing power.

V. UPLOAD

This function is for saving all **waypoints & routes** and **Track Logs** from **Explorer** into a PC for later use. You may share these data with your friends via email.

A. Before Operation

Connect **Explorer** and PC's serial port with data cable, A-30502.

Note! Be sure to check the power supply sufficiently to complete the uploading

B. Operation in Explorer

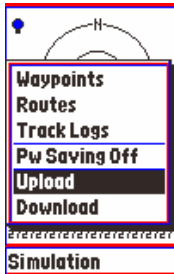

Fig. 5-5-1

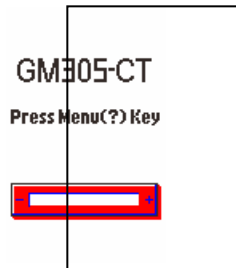

Fig. 5-5-2

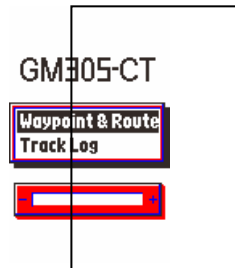

Fig. 5-5-3

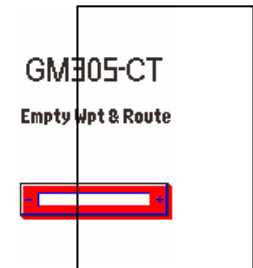
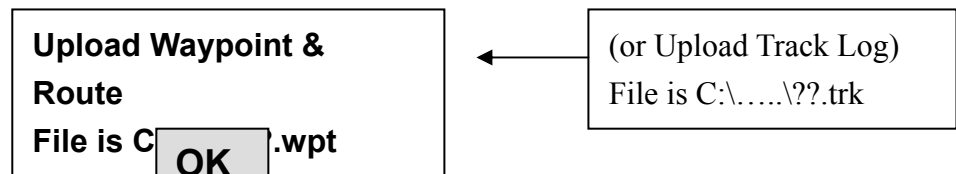

Fig. 5-5-4

- (i) Select **Upload** from **Main Menu** as Fig. 5-5-1 and press “←” as Fig. 5-5-2.
- (ii) Press “?” as Fig. 5-5-3, select **Waypoint & Route** or **Track Log** and press “←”.
- (iii) If there is no data in Waypoint & Route (Track Logs), **Empty Wpt&Route** (or **Empty Track Logs**) will show as Fig. 5-5-4. If there are some data in waypoints & Routes (or Track Logs), **Waiting for Output** will then show in the screen.

C. Operation in PC

- (i) Execute **MapEZ305.exe** file.
- (ii) Click **Port** and select **COM1** or **COM2** which you connected.
- (iii) Click **File** and select **Upload Save As**. The screen will come up **Save As**.
- (iv) Select file branch to save. Name the file (*.wpt for Waypoint&Route or *.tkl for Track Log) to be saved, e.g. Zoo.wpt (or Zoom.tkl). Saving cannot be executed without a file name.
- (v) Click **Save**, the screen will show



- (vi) Click **OK**, the screen will show



- (vii) Click **Transfer**, select **Upload** and click. The screen shows

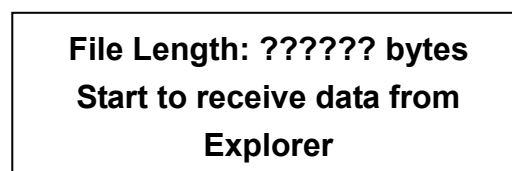

(viii) When complete, the screen shows

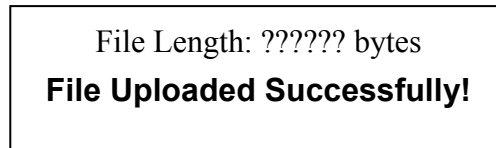

(ix) Press “?” to load another or Press “↵” to return.

Note: Be sure to select file type (*.tki) When up load Track log.

V. Downloading

This function is for downloading Map, Waypoint&Route, Track Logs and Font from PC to **Explorer**.

A. Before Operation

Connect **Explorer** and PC’s serial port with data cable, A-30502.

Note! Be sure to check the power supply sufficiently to complete the uploading

B. Operating in Explorer

- (i) Select **Down Load** as Fig. 5-5-5 from **Main Menu** and press “←” to go to the page as Fig. 5-5-6.
- (ii) Press “?” to select an item to be downloaded as Fig. 5-5-7 and press “←”
- (iii) “**Waiting for Input**” will show up as Fig. 5-5-8.



Fig. 5-5-5



Fig. 5-5-6



Fig. 5-5-7

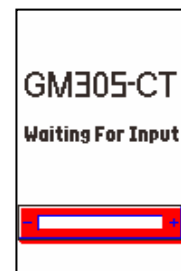

Fig. 5-5-8

C. Operation in PC **

- (i) Execute **MapEZ305.exe**.
- (ii) Click **Port** and select **COM1** or **COM2** which you connected.
- (iii) Click **File** and select **Download Open**. “**Open Field**” will show up in the screen.
- (iv) Select File Name and File Type, Map file (*.crd), Waypoint&Route file (*.wpt), Track Log file (*.tkl) and Font file (*.fnt).
- (v) After Opening file, the screen displays as

File Length: ???????

When downloading map file to GM-305-DT \ GM-305-HT, the map size must be smaller than the memory size built-in the unit. If the map size is too big, the screen will show:

Map size too big, Over xxxx bytes

the overage to the built-in memory size

(vi) Click **Transfer** and **Download**. The screen shows:

File Length: ??????? bytes
Transferring data to Explorer
??% completed

(vii) When complete, it will say:

File Downloaded Successfully!

(viii) Press “?” to load another or Press “↶” to return.

IMPORTANT!!!

You may merge several maps and download them into Explorer memory.

(i) Execute **MapEZ305.exe**.

(ii) Click **File** and select **Merge**. **Open Field** will show up in the screen.

(iii) Click the first map file (*.crd), then **Hold** **ctrl** and click 2nd, 3rd...map file, then click “OK”.

(iv) Select a destination and a map name to store the merged file. The screen shows:

Merge Processing
Cancel

Note: The merging can be terminated at any time by pressing **Cancel** icon.

(v) When complete, the screen shows map size. Click **Transfer** and **Download**. The rest steps are the same as downloading single map file.

CAUTIONS! If the data is not 100% transferred, you need to download again.

VII. Operation System (HOLUX O.S.) Upgrading

This function is for upgrading your **Explorer** O.S.. You may get the newest version of **Explorer** O.S. from our web site or your local distributor free of charge within 1 year from the date of purchase.

A. Before Operation

Connect **Explorer** and PC's serial port with data cable, A-30502.

Note! Be sure to check the power supply sufficiently to complete the uploading

B. Operation in Explorer **

(i) Turn off the unit.

(ii) Press and hold both “?” and “” for 2 seconds to come up the page as follows:

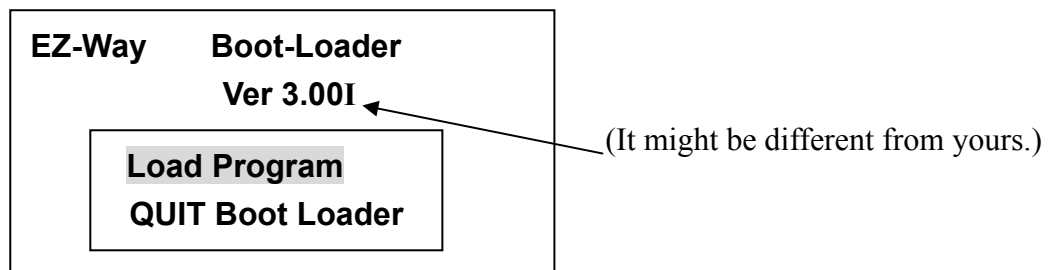

(iii) If you intend to quit, select **Quit** and press “” to turn off the unit.

(iv) Select **Load program** and press “”, the screen shows

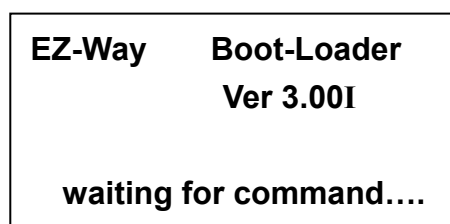

(v) If you intend to quit while **waiting for command** shows, you have to remove batteries and resume power after 5 seconds.

C. Operation in PC **

(i) Execute **MapEZ305.exe**.

(ii) Click **Port** and select **COM1** or **COM2** which you connected.

(iii) Click **File** and select **Download Open**. **Open Field** will show up in the screen.

(iv) Click the file to be downloaded, e.g. V103EID.bin.

Definition of V103EID

V103: Version 1.03.

C: Language

C for Chinese

(iv) Click **Transfer** and **Download**. The screen will show

File Length: ?????bytes
Transferring data to Explorer
??% complete

(v) When complete, it will say:

File Download Successfully!

(vi) will turn off automatically.

Note: It is vital that the cable will not become disconnected during download.

Chapter 6 SPECIFICATION

I. MAP

A. Display Scale:

- (i) Screen width: **400m ~ 3,000km**.
- (ii) Map layer: **12 levels** for zooming in/out.

B. Map Memory:

- (i) GM-305-WT: **0 Byte**.
- (ii) GM-305-DT: **2M Byte**.
- (iii) GM-305-HT: **8M Byte**.

II. NAVIGATION

A. Waypoints: 500 maximum, including name, symbol, comment and display.

B. Routes: 20 maximum, up to **30** waypoints each.

C. Track logs: 6 maximum -- **5** in back up and **1** in use. Up to **2,500** points each.

III. FUNCTION

A. Receiving and tracking **12** satellites.

B. Acquiring Time:

- (i) Cold start: **75** seconds averaged.
- (ii) Warm start: **40** seconds averaged.
- (iii) Hot start: **15** seconds averaged.
- (iv) Acquiring rate: **0.1** second.
- (v) Updating Rate: **1** second.

IV. ACCURACY

A. Position: **5-25** meters.

B. Speed: **0.1** m/sec.

C. Time: **±1μs**.

V. LIMITATION

A. Latitude: **-1,000m ~ 18,000m**.

B. Speed: **< 515** m/sec.

C. G: **±4G**.

VI. INTERFACE

RS-232 for data communication and NMEA output.

VII. ANTENNA

- A. Built-in: patch antenna.
- B. Optional: External antenna with SMA connector.

XIII. PHYSICAL

- A. Size: **153 x 60 x 34 mm**.
- B. Weight: **170g** without battery.
- C. Battery: **4 AA battery, 0.15 – 0.66W**.

IX. DISPLAY

- A. 4-gray, Black & White.
- B. Size: **6.0 x 3.8 cm**.
- C. Backlight: high contrast electroluminescent.
- D. Resolution: **100 x 160 dots**.

X. MISC.

- A. Operation keys:
 - 6 function, 1 on/off and 1 rocking pad for 8 directions.
- B. Temperature:
 - Operation: **-10~60°C**.
 - Storage: **-40~85°C**.

I. BASIC SETTING

- A. Power saving: **ON**
- B. Display (GM-305-DT, GM-305-HT only):
 - (i) Interesting point: **Waypoint only**
 - (ii) Road: **All Roads**
- C. Cursor speed: **Low Speed**
- D. Distance measuring: **OFF**
- E. Map orientation: **North Up**
- F. Time: **Greenwich Time**
- G. Navigation: **ON**
- H. Datum: **WGS 1984**
- I. NMEA output: **OFF**
- J. Waypoints: **Starts from W001**
- K. Routes: **Starts from R001**
- L. Waypoints & Routes

Saved in built-in memory. Will **remain in memory** when downloading new map.
- M. Track log: **OFF**

Saved in built-in memory. Will **remain in memory** when downloading new map.

 - (i) Recording mode
 - (a) Distance: **50m**
 - (b) Time: **10sec**
 - (ii) Show: **OFF** (for saved track logs)
- N. Down load / Up load program port: **COM1** (305v100.exe)

II. SPECIAL ENGINEERING SETTING

Both pages as Fig. 7-0-1 and Fig. 7-0-2 are engineering setting. If you are not a specialty, please

do not Configure it. The setting is displayed only vertically, not horizontally. Once a mistake has

been made, please do as follows:

- A. Press and hold "←" for 2 seconds satellite page as Fig. 7-0-1.
- B. Press "?" as Fig. 7-0-2.
- C. Press "←".
- D. Move the marked field to "v" and press "←".

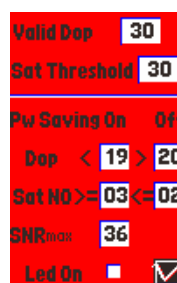

Fig. 7-0-1



Fig. 7-0-2

Chapter 8 TROUBLE SHOOTING

Q1: What should I do when I press "⏻" for several times but fail in turning on the unit?

- A:**
1. Be sure to **press and hold** "⏻" for two seconds. To ensure that the unit is not turned on accidentally, the unit is designed to turn on after the "⏻" being pressed for two seconds. If it doesn't work, please refer to the following.
 2. Remove the batteries for 5 seconds and then re-fill or replace with new ones.

Q2: Why does the unit not respond to my press?

- A:** Press slightly and firmly again or press counter key. If you press the left key and get no respond, try the right one. The correct way to have a key function is to press it perpendicularly. Most of the keys are able to function in both press and hold. If still no function, remove the batteries then try again.

Q3: Why does the unit not respond when I press the direction keys "▲", "▼", "◀" or "▶" to move map?

- A:**
1. In navigation mode, e.g. on map, at the bottom right hand corner there is a "▲" only. There will not be a cursor "↔" to move the map. Press and hold any direction key for one second to have the Cursor appear to move. Please refer to **F. Moving map in page 15**.
 2. If it still does not respond, remove the batteries for 5 seconds and then re-fill.

Q4: I moved map to other page. What should I do to return to my current position?

- A:**
1. In navigation mode, e.g. on map, in the bottom right hand corner is "▲", press "↔" to return to your Current position.
 2. In view map mode, e.g. on map, in the bottom right hand corner is "⊕", press "←" to return to navigation mode to your current position.

Q5: Why does the unit not identify my current position, I am not in the shade?

- A:**
1. Check the antenna if it is facing up to the sky as shown in the description in page **10**.
 2. **Explorer** needs, at least, to lock 3 satellites to identify the current position. Sometimes the elevation of all satellites on orbit is small i.e. all satellites signals are "unhealthy" to be locked, or be used even being locked. The **Explorer** will need clearer view to the sky to acquire more than 3 "healthy" satellites to identify the position.
 3. Check if you use **Simulation** mode. If yes, please press "?", select **Navigation** and press "←". Please refer to P.13 Simulation.

Q6: When I preprogram my route, I find my destination, say **Yellow Stone**, and operate from **MENU** "?" to set a new waypoint at the place. I do select **Display All** but fail to see an icon there. Why?

- A:** The waypoint you created may not be at Yellow Stone. It is your current position. You have to create waypoint by Method 2 of "Create new waypoint". It is to press "←" for one second to have the page as Fig. 5-1-5 show up and then press "←". Please practice creating a waypoint by both Method 1 and Method 2.
- Q7:** I find my destination and have the shortcut on but fail to return to the previous position. What should I do?
- A:** Press "←". This is for you to return to navigation mode "▲" from view map mode "⊕". When You search an object, the unit changes and remains in view map mode. The position is then not not your real position.
- Q8.** On navigation mode when I moved cursor to create a new waypoint by method 2, I can not find it in the map. I am on my current position. What's wrong?
- A:** If you intend to create a new waypoint on navigation mode, please press "←" to change the unit to view map mode (with a "⊕" mark on right down corner).
- Q9.** I have pressed "←" when "Tracking full, Save or Clear" appears during navigation on the road. Once I turn on the unit next time it shows again. What's wrong with my **Explorer**?
- A:** You need to save or to clear the current track log. Details please refer **Further operation on Track Log** in page 29.

Appendix A DATUM

The **Explorer** supports 219 datums. You may change it by following **Change Datum** step by step on page. 15 in Chapter 4. Its setting is WGS-84 when you use the unit initially.

Note: dX, dY and dZ are the 3 dimension tolerance with WGS-84 (scale: meter).

	Datum	dX	dY	dZ	Ellipsoid	Region of use	Name in EXPLORER
1.	WGS-84	0	0	0	WGS 84	Global	WGS 1984
2.	Adindan	-118	-14	218	Clarke 1880	Burkina Faso	Adindan- Burkina Faso
3.	Adindan	-134	-2	210	Clarke 1880	Cameroon	Adindan- Cameroon
4.	Adindan	-165	-11	206	Clarke 1880	Ethiopia	Adindan- Ethiopia
5.	Adindan	-123	-20	220	Clarke 1880	Mali	Adindan- Mali
6.	Adindan	-166	-15	204	Clarke 1880	Mean for Ethiopia; Sudan	Adindan-Regional Mean
7.	Adindan	-128	-18	224	Clarke 1880	Senegal	Adindan- Senegal
8.	Adindan	-161	-14	205	Clarke 1880	Sudan	Adindan- Sudan
9.	Afgooye	-43	-163	45	Krassovsky 1940	Somalia	Afgooye- Somalia
10.	Ain el Abd 1970	-150	-250	-1	International 1924	Bahrain	Ain el Abd'70- Bahrain
11.	Ain el Abd 1970	-143	-236	7	International 1924	Saudi Arabia	Ain el Abd'70- Saudi Arabia
12.	American Samoa 1962	-115	118	426	Clarke 1866	American Samoa Islands	American Samoa'62
13.	Anna 1 Astro 1965	-491	-22	435	Australian National	Cocos Islands	Anna 1 Astro'65
14.	Antigua Island Astro 1943	-270	13	62	Clarke 1880	Antigua (Leeward Islands)	Antigua Island Astro'43
15.	Arc 1950	-138	-105	-289	Clarke 1880	Botswana	Arc'50- Botswana
16.	Arc 1950	-153	-5	-292	Clarke 1880	Burundi	Arc'50- Burundi
17.	Arc 1950	-125	-108	-295	Clarke 1880	Lesotho	Arc'50- Lesotho
18.	Arc 1950	-161	-73	-317	Clarke 1880	Malawi	Arc'50- Malawi
19.	Arc 1950	-143	-90	-294	Clarke 1880	Mean for Botswana; Lesotho; Malawi; Swaziland; Zaire; Zambia; Zimbabwe	Arc'50-Regional Mean
20.	Arc 1950	-134	-105	-295	Clarke 1880	Swaziland	Arc'50- Swaziland
21.	Arc 1950	-169	-19	-278	Clarke 1880	Zaire	Arc'50- Zaire
22.	Arc 1950	-147	-74	-283	Clarke 1880	Zambia	Arc'50- Zambia
23.	Arc 1950	-142	-96	-293	Clarke 1880	Zimbabwe	Arc'50- Zimbabwe
24.	Arc 1960	-160	-6	-302	Clarke 1880	MEAN FOR Kenya; Tanzania	Arc'60- Mean of Kenya, Tanzania
25.	Arc 1960	-157	-2	-299	Clarke 1880	Kenya	Arc'60- Kenya
26.	Arc 1960	-175	-23	-303	Clarke 1880	Tanzania	Arc'60- Tanzania
27.	Ascension Island 1958	-205	107	53	International 1924	Ascension Island	Ascension Island'58
28.	Astro Beacon E 1945	145	75	-272	International 1924	Iwo Jima	Astro Beacon E'45
29.	Astro DOS 71/4	-320	550	-494	International 1924	St Helena Island	Astro DOS 71/4
30.	Astro Tern Island (FRIG) 1961	114	-116	-333	International 1924	Tern Island	Astro Tern Island
31.	Astronomical Station 1952	124	-234	-25	International 1924	Marcus Island	Astronomical Station'52
32.	Australian Geodetic	-133	-48	148	Australian National	Australia; Tasmania	Australian

	1966						Geodetic'66
33.	Australian Geodetic 1984	-134	-48	149	Australian National	Australia; Tasmania	Australian Geodetic'84
34.	Ayabelle Lighthouse	-79	-129	145	Clarke 1880	Djibouti	Ayabelle Lighthouse
35.	Bellevue (IGN)	-127	-769	472	International 1924	Efate & Erromango Islands	Bellevue
36.	Bermuda 1957	-73	213	296	Clarke 1866	Bermuda	Bermuda 1957
37.	Bissau	-173	253	27	International 1924	Guinea-Bissau	Bissau
38.	Bogota Observatory	307	304	-318	International 1924	Colombia	Bogota Observatory
39.	Bukit Rimpah	-384	664	-48	Bessel 1841	Indonesia (Bangka & Belitung Ids)	Bukit Rimpah
40.	Camp Area Astro	-104	-129	239	International 1924	Antarctica (McMurdo Camp Area)	Camp Area Astro
41.	Campo Inchauspe	-148	136	90	International 1924	Argentina	Campo Inchauspe
42.	Canton Astro 1966	298	-304	-375	International 1924	Phoenix Islands	Canton Astro'66
43.	Cape	-136	-108	-292	Clarke 1880	South Africa	Cape- South Africa
44.	Cape Canaveral	-2	151	181	Clarke 1866	Bahamas; Florida	Cape Canaveral
45.	Carthage	-263	6	431	Clarke 1880	Tunisia	Carthage- Tunisia
46.	Chatham Island Astro 1971	175	-38	113	International 1924	New Zealand (Chatham Island)	Chatham Island Astro'71
47.	Chua Astro	-134	229	-29	International 1924	Paraguay	Chua Astro- Paraguay
48.	Corrego Alegre	-206	172	-6	International 1924	Brazil	Corrego Alegre
49.	Dabola	-83	37	124	Clarke 1880	Guinea	Dabola- Guinea
50.	Deception Island	260	12	-147	Clarke 1880	Deception Island; Antarctica	Deception Island
51.	Djakarta (Batavia)	-377	681	-50	Bessel 1841	Indonesia (Sumatra)	Djakarta-Batavia
52.	DOS 1968	230	-199	-752	International 1924	New Georgia Islands (Gizo Island)	DOS 1968
53.	Easter Island 1967	211	147	111	International 1924	Easter Island	Easter Island'67
54.	Estonia Coordinate System 1937	374	150	588	Bessel 1841	Estonia	Estonia Coord Sys'37
55.	European 1950	-104	-101	-140	International 1924	Cyprus	Euro'50- Cyprus
56.	European 1950	-130	-117	-151	International 1924	Egypt	Euro'50- Egypt
57.	European 1950	-86	-96	-120	International 1924	England; Channel Islands; Scotland; Shetland Islands	Euro'50- England
58.	European 1950	-86	-96	-120	International 1924	England; Ireland; Scotland; Shetland Islands	Euro'50- North Regional Mean
59.	European 1950	-87	-95	-120	International 1924	Finland; Norway	Euro'50- Finland,Norway
60.	European 1950	-84	-95	-130	International 1924	Greece	Euro'50- Greece
61.	European 1950	-117	-132	-164	International 1924	Iran	Euro'50- Iran
62.	European 1950	-97	-103	-120	International 1924	Italy (Sardinia)	Euro'50-Italy-Sardinia
63.	European 1950	-97	-88	-135	International 1924	Italy (Sicily)	Euro'50-Italy-Sicily
64.	European 1950	-107	-88	-149	International 1924	Malta	Euro'50-Malta
65.	European 1950	-87	-98	-121	International 1924	Mean for Austria; Belgium; Denmark; Finland; France; W Germany; Gibraltar; Greece; Italy; Luxembourg; Netherlands; Norway; Portugal; Spain; Sweden; Switzerland	Euro'50-West Regional Mean
66.	European 1950	-87	-96	-120	International 1924	Mean for Austria; Denmark; France; W Germany; Netherlands;	Euro'50-East Regional Mean

						Switzerland	
67.	European 1950	-103	-106	-141	International 1924	Mean for Iraq; Israel; Jordan; Lebanon; Kuwait; Saudi Arabia; Syria	Euro'50-South Regional Mean
68.	European 1950	-84	-107	-120	International 1924	Portugal; Spain	Euro'50- Portugal,Spain
69.	European 1950	-112	-77	-145	International 1924	Tunisia	Euro'50- Tunisia
70.	European 1979	-86	-98	-119	International 1924	Mean for Austria; Finland; Netherlands; Norway; Spain; Sweden; Switzerland	European 1979
71.	Fort Thomas 1955	-7	215	225	Clarke 1880	Nevis; St. Kitts (Leeward Islands)	Fort Thomas 1955
72.	Gan 1970	-133	-321	50	International 1924	Republic of Maldives	Gan 1970
73.	Geodetic Datum 1949	84	-22	209	International 1924	New Zealand	Geodetic Datum'49
74.	Graciosa Base SW 1948	-104	167	-38	International 1924	Azores (Faial; Graciosa; Pico; Sao Jorge; Terceira)	Graciosa Base SW'48
75.	Guam 1963	-100	-248	259	Clarke 1866	Guam	Guam'63 Guam
76.	Gunung Segara	-403	684	41	Bessel 1841	Indonesia (Kalimantan)	Gunung Segara
77.	GUX 1 Astro	252	-209	-751	International 1924	Guadalcanal Island	GUX 1 Astro
78.	Herat North	-333	-222	114	International 1924	Afghanistan	Herat North
79.	Hermannskogel Datum	653	-212	449	Bessel 1841 (Namibia)	Croatia -Serbia, Bosnia-Herzegovina	Hermannskogel Datum
80.	Hjorsey 1955	-73	46	-86	International 1924	Iceland	Hjorsey 1955
81.	Hong Kong 1963	-156	-271	-189	International 1924	Hong Kong	Hong Kong'63
82.	Hu-Tzu-Shan	-637	-549	-203	International 1924	Taiwan	Hu-Tzu-Shan
83.	Indian	282	726	254	Everest (India 1830)	Bangladesh	Indian- Bangladesh
84.	Indian	295	736	257	Everest (India 1956)	India; Nepal	Indian- India,Nepal
85.	Indian	283	682	231	Everest (Pakistan)	Pakistan	Indian- Pakistan
86.	Indian 1954	217	823	299	Everest (India 1830)	Thailand	Indian 1954
87.	Indian 1960	182	915	344	Everest (India 1830)	Vietnam (Con Son Island)	Indian'60- Con Son Island
88.	Indian 1960	198	881	317	Everest (India 1830)	Vietnam (Near 16øN))	Indian'60-Vietnam
89.	Indian 1975	210	814	289	Everest (India 1830)	Thailand	Indian 1975
90.	Indonesian 1974	-24	-15	5	Indonesian 1974	Indonesia	Indonesian'74
91.	Ireland 1965	506	-122	611	Modified Airy	Ireland	Ireland 1965
92.	ISTS 061 Astro 1968	-794	119	-298	International 1924	South Georgia Islands	ISTS 061 Astro'68
93.	ISTS 073 Astro 1969	208	-435	-229	International 1924	Diego Garcia	ISTS 073 Astro'69
94.	Johnston Island 1961	189	-79	-202	International 1924	Johnston Island	Johnston Island'61
95.	Kandawala	-97	787	86	Everest (India 1830)	Sri Lanka	Kandawala
96.	Kerguelen Island 1949	145	-187	103	International 1924	Kerguelen Island	Kerguelen Island'49
97.	Kertau 1948	-11	851	5	Everest (Malay. & Sing)	West Malaysia & Singapore	Kertau 1948
98.	Kusaie Astro 1951	647	1777	-1124	International 1924	Caroline Islands	Kusaie Astro'51
99.	Korean Geodetic System	0	0	0	GRS 80	South Korea	Korean Geo Sys
100.	L. C. 5 Astro 1961	42	124	147	Clarke 1866	Cayman Brac Island	L. C. 5 Astro'61
101.	Leigon	-130	29	364	Clarke 1880	Ghana	Leigon
102.	Liberia 1964	-90	40	88	Clarke 1880	Liberia	Liberia 1964
103.	Luzon	-133	-77	-51	Clarke 1866	Philippines (Excluding Mindanao)	Luzon-Philip
104.	Luzon	-133	-79	-72	Clarke 1866	Philippines (Mindanao)	Luzon-Philip-Mindanao
105.	M'Poraloko	-74	-130	42	Clarke 1880	Gabon	M'Poraloko

106	Mahe 1971	41	-220	-134	Clarke 1880	Mahe Island	Mahe 1971
107	Massawa	639	405	60	Bessel 1841	Ethiopia (Eritrea)	Massawa
108	Merchich	31	146	47	Clarke 1880	Morocco	Merchich
109	Midway Astro 1961	912	-58	1227	International 1924	Midway Islands	Midway Astro'61
110	Minna	-81	-84	115	Clarke 1880	Cameroon	Minna- Cameroon
111	Minna	-92	-93	122	Clarke 1880	Nigeria	Minna- Nigeria
112	Montserrat Island Astro 1958	174	359	365	Clarke 1880	Montserrat (Leeward Islands)	Montserrat Island Astro'58
113	Nahrwan	-247	-148	369	Clarke 1880	Oman (Masirah Island)	Nahrwan-Oman-Masirah Island
114	Nahrwan	-243	-192	477	Clarke 1880	Saudi Arabia	Nahrwan- Saudi Arabia
115	Nahrwan	-249	-156	381	Clarke 1880	United Arab Emirates	Nahrwan- United Arab Emirates
116	Naparima BWI	-10	375	165	International 1924	Trinidad & Tobago	Naparima BWI
117	North American 1927	-5	135	172	Clarke 1866	Alaska (Excluding Aleutian Ids)	N-Amer'27-Alaska
118	North American 1927	-2	152	149	Clarke 1866	Alaska (Aleutian Ids East of 180°W)	N-Amer'27-Aleutian Ids E
119	North American 1927	2	204	105	Clarke 1866	Alaska (Aleutian Ids West of 180°W)	N-Amer'27-Aleutian Ids W
120	North American 1927	-4	154	178	Clarke 1866	Bahamas (Except San Salvador Id)	N-Amer'27-Bahamas
121	North American 1927	1	140	165	Clarke 1866	Bahamas (San Salvador Island)	N-Amer'27-San Salvador
122	North American 1927	-7	162	188	Clarke 1866	Canada (Alberta; British Columbia)	N-Amer'27-Alberta
123	North American 1927	-9	157	184	Clarke 1866	Canada (Manitoba; Ontario)	N-Amer'27- Manitoba, Ontario
124	North American 1927	-22	160	190	Clarke 1866	Canada (New Brunswick; Newfoundland; Nova Scotia; Quebec)	N-Amer'27- New Brunswick
125	North American 1927	4	159	188	Clarke 1866	Canada (Northwest Territories; Saskatchewan)	N-Amer'27- Saskatchewan
126	North American 1927	-7	139	181	Clarke 1866	Canada (Yukon)	N-Amer'27- Yukon
127	North American 1927	0	125	201	Clarke 1866	Canal Zone	N-Amer'27-Canal Zone
128	North American 1927	-9	152	178	Clarke 1866	Cuba	N-Amer'27-Cuba
129	North American 1927	11	114	195	Clarke 1866	Greenland (Hayes Peninsula)	N-Amer'27-Greenland
130	North American 1927	-3	142	183	Clarke 1866	Mean for Antigua; Barbados; Barbuda; Caicos Islands; Cuba; Dominican Republic; Grand Cayman; Jamaica; Turks Islands	N-Amer'27-Antigua, Barbados
131	North American 1927	0	125	194	Clarke 1866	Mean for Belize; Costa Rica; El Salvador; Guatemala; Honduras; Nicaragua	N-Amer'27-Costa Rica, El Salvador
132	North American 1927	-10	158	187	Clarke 1866	Mean for Canada	N-Amer'27- Mean of Canada
133	North American 1927	-8	160	176	Clarke 1866	Mean for Conus	N-Amer'27-Mean of Conus
134	North American 1927	-9	161	179	Clarke 1866	Mean for Conus (East of Mississippi; River	N-Amer'27-E-Mississippi

						Including Louisiana; Missouri; Minnesota)	
135	North American 1927	-8	159	175	Clarke 1866	Mean for Conus (West of Mississippi; River Excluding Louisiana; Minnesota; Missouri)	N-Amer'27-W-Mississippi
136	North American 1927	-12	130	190	Clarke 1866	Mexico	N-Amer'27-Mexico
137	North American 1983	0	0	0	GRS 80	Alaska (Excluding Aleutian Ids)	N-Amer'83-Alaska
138	North American 1983	-2	0	4	GRS 80	Aleutian Ids	N-Amer'83-Aleutian Ids
139	North American 1983	0	0	0	GRS 80	Canada	N-Amer'83-Canada
140	North American 1983	0	0	0	GRS 80	Conus	N-Amer'83-Conus
141	North American 1983	1	1	-1	GRS 80	Hawaii	N-Amer'83-Hawaii
142	North American 1983	0	0	0	GRS 80	Mexico; Central America	N-Amer'83-Mexico, Central America
143	North Sahara 1959	-186	-93	310	Clarke 1880	Algeria	North Sahara'59
144	Observatorio Meteorologico 1939	-425	-169	81	International 1924	Azores (Corvo & Flores Islands)	Observatorio Meteorologico'39
145	Old Egyptian 1907	-130	110	-13	Helmert 1906	Egypt	Old Egyptian 1907
146	Old Hawaiian	89	-279	-183	Clarke 1866	Hawaii	Old Hawaiian- Hawaii
147	Old Hawaiian	45	-290	-172	Clarke 1866	Kauai	Old Hawaiian- Kauai
148	Old Hawaiian	65	-290	-190	Clarke 1866	Maui	Old Hawaiian- Maui
149	Old Hawaiian	61	-285	-181	Clarke 1866	Mean For Hawaii; Kauai; Maui; Oahu	Old Hawaiian-Regional Mean
150	Old Hawaiian	58	-283	-182	Clarke 1866	Oahu	Old Hawaiian- Oahu
151	Oman	-346	-1	224	Clarke 1880	Oman	Oman
152	Ordnance Survey Great Britain 1936	371	-112	434	Airy 1830	England	Ord Sur GB'36-England
153	Ordnance Survey Great Britain 1936	371	-111	434	Airy 1830	England; Isle of Man; Wales	Ord Sur GB'36- Isle of Man
154	Ordnance Survey Great Britain 1936	375	-111	431	Airy 1830	Mean For England; Isle of Man; Scotland; Shetland Islands; Wales	Ord Sur GB'36-Regional Mean
155	Ordnance Survey Great Britain 1936	384	-111	425	Airy 1830	Scotland; Shetland Islands	Ord Sur GB'36-Scotland, Shetland
156	Ordnance Survey Great Britain 1936	370	-108	434	Airy 1830	Wales	Ord Sur GB'36- Wales
157	Pico de las Nieves	-307	-92	127	International 1924	Canary Islands	Pico de las Nieves
158	Pitcairn Astro 1967	185	165	42	International 1924	Pitcairn Island	Pitcairn Astro 1967
159	Point 58	-106	-129	165	Clarke 1880	MEAN FOR Burkina Faso & Niger	Point 58
160	Pointe Noire 1948	-148	51	-291	Clarke 1880	Congo	Pointe Noire 1948
161	Porto Santo 1936	-499	-249	314	International 1924	Porto Santo; Madeira Islands	Porto Santo 1936
162	Provisional South American 1956	-270	188	-388	International 1924	Bolivia	Prov S-Amer'56-Bolivia
163	Provisional South American 1956	-270	183	-390	International 1924	Chile (Northern; Near 19 °S)	Prov S-Amer'56-Chile-North
164	Provisional South American 1956	-305	243	-442	International 1924	Chile (Southern; Near 43 °S)	Prov S-Amer'56-Chile-South
165	Provisional South American 1956	-282	169	-371	International 1924	Colombia	Prov S-Amer'56-Colombia

Ecuador	Prov S-Amer'56- Ecuador
Guyana	Prov S-Amer'56- Guyana
Mean for Bolivia; Chile; Colombia; Ecuador; Guyana; Peru; Venezuela	Prov S-Amer'56-Regional Mean
Peru	Prov S-Amer'56- Peru
Venezuela	Prov S-Amer'56- Venezuela

202	South American 1969,	-58	0	-44	South American 1969	Peru	S-Amer'69- Peru
203	South American 1969,	-45	12	-33	South American 1969	Trinidad & Tobago	S-Amer'69- Trinidad, Tobago
204	South American 1969,	-45	8	-33	South American 1969	Venezuela	S-Amer'69- Venezuela
205	South Asia	7	-10	-26	Modified Fischer 1960	Singapore	South Asia
206	Tananarive Observatory 1925	-189	-242	-91	International 1924	Madagascar	Tananarive Observ'25
207	Timbalai 1948	-679	669	-48	Everest (Sabah Sarawak)	Brunei; E. Malaysia (Sabah Sarawak)	Timbalai 1948
208	Tokyo	-148	507	685	Bessel 1841	Japan	Tokyo- Japan
209	Tokyo	-148	507	685	Bessel 1841	Mean for Japan; South Korea; Okinawa	Tokyo-Regional Mean
210	Tokyo	-158	507	676	Bessel 1841	Okinawa	Tokyo- Okinawa
211	Tokyo	-147	506	687	Bessel 1841	South Korea	Tokyo- South Korea
212	Tristan Astro 1968	-632	438	-609	International 1924	Tristan da Cunha	Tristan Astro'68
213	Viti Levu 1916	51	391	-36	Clarke 1880	Fiji (Viti Levu Island)	Viti Levu 1916
214	Voirol 1960	-123	-206	219	Clarke 1880	Algeria	Voirol 1960
215	Wake Island Astro 1952	276	-57	149	International 1924	Wake Atoll	Wake Island Astro'52
216	Wake-Eniwetok 1960	102	52	-38	Hough 1960	Marshall Islands	Wake-Eniwetok'60
217	WGS 1972	0	0	0	WGS 72	Global Definition	WGS 1972
218	Yacare	-155	171	37	International 1924	Uruguay	Yacare
219	Zanderij	-265	120	-358	International 1924	Suriname	Zanderij