

ZTE Corporation

ZTE C77 CDMA 1X Digital Mobile Phone
User Manual

Copyright © 2008 by ZTE Corporation

All rights reserved.

No part of this publication may be excerpted, reproduced, translated, or utilized in any form or by any means, electronic or mechanical, including photocopying and microfilm, without the prior written permission of ZTE Corporation.

ZTE Corporation operates a policy of continuous development. ZTE Corporation reserves the right to make changes and improvements to any of the products described in this document without prior notice.

Release: V1.0

Manual number:

10 09, 2008

Contents

1. For Your Safety	10
General Care	10
Aircraft Safety	13
Hospital Safety.....	14
General Guidelines	14
Road Safety	15
Vehicles Equipped with an Airbag	16
Third Party Equipment.....	17
Efficient Use.....	17
Radio Frequency (RF) Energy	17
Emergency Services.....	19
FCC Notice	20
Turn on the HAC Setting.....	21
Copyright Notice	21
2. Introduction	22
Overview.....	22
What's Included	22
C77 Technical Specifications.....	23
Phone at a Glance	24
Key Definitions.....	25

C77 User Manual

User Interface.....	27
Indicators and Icons	28
3. Set up Your Phone	30
Battery	30
Install the Battery	31
Charge the Battery.....	32
Remove the Battery	33
Power On/Off Your Phone.....	34
Keyguard Mode	34
Connect to the Network.....	35
Activate Your Phone.....	35
4. Basic Operations.....	36
Make Voice Calls.....	36
Use the Keypad	36
Use the Contacts List.....	36
Use the Last Number Dialed.....	37
Use the Number from the Call History	37
Use Speed Dials	37
Answer Voice Calls.....	38
In-Call Features.....	39
Three-Way Call	40

Call Waiting.....	40
5. Entering Text	42
Key Functions	42
Text Input Modes	43
6. Contacts	46
Contact List.....	47
New Contact	48
Groups	49
Speed Dials	49
7. Calls	50
All Calls.....	50
Missed Calls	51
Incoming Calls	51
Outgoing Calls	51
Call Timers.....	51
8. Messaging	52
Send New	52
Insert	53
Slide	54
Preview.....	54
Erase Item.....	54

C77 User Manual

Cc/Bcc/Sub	55
Save To Drafts	55
Quick Text.....	55
Signature	55
Message Priority	56
Inbox.....	56
Read a Message	56
Reply to a Message	57
Outbox.....	57
Drafts	57
Sent	58
Saved	58
Voice Mail.....	58
Web Alerts.....	59
Settings	59
Message Settings	59
Quick Text Settings.....	60
Memory Info	60
9. Calendar	61
Add an Appointment.....	61
View an Appointment	61
Calendar Options	62

10. WEB	63
11. Music & Media	66
MyTunes	66
Play Your Tunes.....	66
Manage Your Tunes.....	67
MyImages	68
Preloaded Files.....	68
Tunes	68
Images.....	68
Memory Info.....	69
12. Games	70
13. Tools	71
Calculator.....	71
Alarm Clock	72
Edit an Alarm.....	72
Alarm Options	73
Update Phone.....	73
Tip Calc.....	74
World Clock	74
14. Settings	75
Sound Settings	75

C77 User Manual

Ringers	76
Keypad Tone	76
Volume.....	77
Power On/Off Tone.....	77
Alerts.....	77
Systems Switch Tone	78
Display Settings.....	78
Language	79
GPS.....	79
System	79
Call Setup	79
Automatic Keyguard	80
Memory Info.....	80
Phone Info	80
System Settings.....	80
TTY Mode	81
Security.....	82
HAC Mode	83
Airplane Mode On/Off.....	83
15. Glossary	85
16. Troubleshooting	86

17. Index88

1. For Your Safety

General Care

Your handset contains delicate electronic circuitry, magnets and battery systems. You should treat it with care and give particular attention to the following points:

- Do not allow the handset, battery or accessories to come into contact with liquids or moisture at any time. Do not immerse it in any liquid.
- Do not place the handset alongside computer disks, credit cards, travel cards or other magnetic media. The information contained on the disks or cards may be affected by the handset.
- Do not place anything inside the folded handset.
- Do not paint the handset.
- Do not leave the handset or battery in places where the temperature could exceed 140°F, e.g., on a car dashboard or a windowsill, behind glass in direct sunlight, etc.
- Do not remove the handset battery while the handset is switched on.
- Take care not to allow metal objects, such as coins or key rings to contact or short circuit the battery terminals.

- Do not dispose of batteries in fire. The handset's Li-Ion batteries may be safely disposed of at a Li-Ion recycling point.
- Do not put the handset's battery in your mouth, as battery electrolytes may be toxic if swallowed.
- Only use the battery with a charging system that has been qualified with the system per this standard. Use of an unqualified battery or charger may present a risk of fire, explosion, leakage, or other hazard.
- Do not disassemble or open, crush, bend or deform, puncture, or shred.
- Do not short circuit a battery or allow metallic or conductive objects to contact the battery terminals.
- Promptly dispose of used batteries in accordance with local regulations.
- Improper battery use may result in a fire, explosion, or other hazard.
- Do not put a battery into a microwave oven, dryer or high-pressure container.
- Do not contact battery directly into an electric outlet or cigarette lighter charger. Use only authorized chargers.
- Do not puncture the battery with a sharp object such as a needle.
- When the battery is disposed, be sure it is non-conducting by applying vinyl tape to the (+) and (-) terminals.

C77 User Manual

- Do not drop, throw, or subject the handset to rough treatment.
- Stop using the battery if abnormal heat, odor, discoloration, deformation, or abnormal condition is detected during use, charge or storage.
- Do not use with a damaged or deformed battery.
- Do not solder the battery directly.
- Remove the battery whose life cycle has expired from equipment immediately.
- The earpiece may become warm during normal use. Also, the handset itself may become warm while the battery is being charged.
- When a handset is in vibration mode, the vibration may cause the handset to move.
- Be careful not to place the handset near heat sources (such as a heater).
- Use a damp or anti-static cloth to clean the handset. Do not use an ordinary dry cloth or electrostatic cloth. Do not use chemical or abrasive cleaners as these could damage the casing.
- Third party equipment: The use of third party equipment, cables, or accessories, not made or authorized by ZTE, may invalidate the warranty of your phone and also adversely affect the phone's safety and operation.

- Remember to make backup copies of all important data on your handset.
- Remember to recycle: The cardboard packing supplied with this handset is ideal for recycling.

Warning: In the unlikely event of a battery leak, take care to keep the battery discharge away from your eyes and skin. If the leakage does come into contact with the eyes or skin, flush thoroughly with clean water and consult with a doctor.

Aircraft Safety

- Switch off your phone or activate the airplane mode when inside or near an aircraft. Use of handsets in an aircraft may be dangerous to the operation of the aircraft and may disrupt the cellular network. Failure to observe this instruction may lead to suspension or denial of phone service to the offender, or legal action, or both.
- Airplane mode allows you to use many of your phone's features, such as games, calculator, voice memos, and many others when you are in an airplane or other area where wireless signals may cause interference. In the airplane mode, you are prohibited from making or receiving voice/data calls.

Hospital Safety

- Switch off your phone and remove its battery in areas where handset use is prohibited.
- Follow the instructions given by any respective medical facility regarding the use of cellular handsets on their premises.

General Guidelines

- Many jurisdictions have laws and regulations about taking pictures in public or private areas regarding the processing and further use of such pictures. ZTE encourages its customers to obey all laws and to honor the personal rights of others.
- Check the roaming agreement availability with your network operator.
- The use of mobile phones is not allowed in some radiation sensitive areas, such as hospitals, research centers, and airplanes. The user is responsible to power-off the device. If there is any uncertainty, the battery should be removed.
- Observe any signs that indicate to power off your handset, such as those near gas stations, or explosives and power off the handset/device upon them.
- If you have a heart condition, be careful with the setting of call vibration or tone volume.
- Do not allow children to play with the handset, charger, or batteries.

- The operation of some medical electronic devices, such as hearing aids and pacemakers, may be affected if a handset is used next to them. Observe any Caution signs and the manufacturer's recommendations.
- Take care not to put your phone in the back pocket of your pants and then sit on the phone. Also, do not put your phone at the bottom of a bag where it may be subject to excessive weight or pressure as this may damage the LCD and cause them to malfunction.
- Your phone contains metal, which may cause you to develop an itch, rash or eczema depending on your physical condition.
- Do not leave the phone discharged or without a battery for a long period of time. Otherwise some data may be erased.

Road Safety

- You must exercise proper control of your vehicle at all times. Give your full attention to driving.
- Observe all of the recommendations contained in your local traffic safety documentation.
- Pull off the road and park before making or answering a call, if driving conditions require so. Check if local laws and/or regulations restrict the use of cellular phones while driving.

C77 User Manual

- You must not stop on the hard shoulder of a motorway to answer or make a call, except in emergency situations.
- Switch off your handset at a refueling point, such as a gas station, even if you are not refueling your own car.
- Do not store or carry flammable or explosive materials in the same compartment as the handset.
- Electronic systems in vehicle, such as anti-lock brakes, speed control and fuel injection systems are not normally affected by radio transmissions. The manufacturer of such equipment may advise if it is adequately shielded from radio transmissions. If you suspect vehicle problems caused by the radio transmitter in handset, consult your dealer and do not switch on the handset until your handset has been checked by a qualified technician.

Vehicles Equipped with an Airbag

An airbag inflates with great force. Do not place objects, including either installed or portable wireless equipment, in the area over the airbag or in the airbag deployment area. If in-vehicle wireless equipment is improperly installed and the airbag inflates, serious injury could result.

Third Party Equipment

The use of third party equipment, cables or accessories, not made or authorized by ZTE, may invalidate the warranty of the handset and also adversely affect the handset's operation. For example, use only the ZTE charger supplied with the handset.

Efficient Use

For optimum performance with minimum power consumption, do not cover the antenna area (it is on the bottom of your phone) with your hand. Covering the antenna affects the call quality, may cause the handset to operate at higher power levels than otherwise needed, and may shorten talk and standby times.

Radio Frequency (RF) Energy

This model phone meets the government's requirements for exposure to radio waves. This phone is designed and manufactured not to exceed the emission limits for exposure to radio frequency (RF) energy set by the Federal Communications Commission of the U.S. Government:

- The exposure standard for wireless mobile phones employs a unit of measurement known as the Specific Absorption Rate, or SAR. The SAR limit set by the FCC is 1.6W/kg. * Tests for SAR are conducted using standard operating positions accepted by the FCC with the phone transmitting at its

C77 User Manual

highest certified power level in all tested frequency bands. Although the SAR is determined at the highest certified power level, the actual SAR level of the phone while operating can be well below the maximum value. This is because the phone is designed to operate at multiple power levels so as to use only the power required to reach the network. In general, the closer you are to a wireless base station antenna, the lower the power output.

- The highest SAR value for the model phone as reported to the FCC when tested for use at the ear is 1.45 W/kg and when worn on the body, as described in this user guide, is 0.723 W/kg (Body-worn measurements differ among phone models, depending upon available enhancements and FCC requirements.)
- While there may be differences between the SAR levels of various phones and at various positions, they all meet the government requirement.
- The FCC has granted an Equipment Authorization for this model phone with all reported SAR levels evaluated as in compliance with the FCC RF exposure guidelines. SAR information on this model phone is on file with the FCC and can be found under the Display Grant section of <http://www.fcc.gov/oet/fccid> after searching on FCC ID: Q78-ZTEC77.
- For body worn operation, this phone has been tested and meets the FCC RF exposure guidelines for use with an accessory that contains no metal and the

positions the handset a minimum of 1.5 cm from the body. Use of other enhancements may not ensure compliance with FCC RF exposure guidelines. If you do not use a body-worn accessory and are not holding the phone at the ear, position the handset a minimum of 1.5 cm from your body when the phone is switched on.

Emergency Services

To make an emergency call in any country:

1. Ensure your handset is ON and in service.
2. Press the End Key as many times as needed to clear the display and ready the device for calls.
3. Enter a local emergency number.
4. Press the Send Key to dial the number. Follow instructions received and do not end the call until told to do so.

Note: Tell the operator which service you require: Police, Ambulance, Fire Engine, Coastguard or Mountain Rescue Service. Give your position and, if possible, remain stationary and maintain contact. Due to the nature of the cellular system, the connection of emergency calls cannot be guaranteed. You should never rely on any wireless device for essential communication such as medical emergencies.

FCC Notice

This mobile phone complies with part 15 of the FCC Rules. Operation is subject to the following two conditions: (1) This device may not cause harmful interference, and (2) this device must accept any interference received, including interference that may cause undesired operation.

This mobile phone has been tested and found to comply with the limits for a Class B digital device, pursuant to Part 15 of the FCC Rules. These limits are designed to provide reasonable protection against harmful interference in a residential installation. This equipment generates, uses, and can radiate radio frequency energy and, if not installed and used in accordance with the instructions, may cause harmful interference to radio communications. However, there is no guarantee that interference will not occur in a particular installation. If this equipment does cause harmful interference to radio or television reception, which can be determined by turning the equipment off and on, the user is encouraged to try to correct the interference by one or more of the following measures:

- ✧ Reorient or relocate the receiving antenna.
- ✧ Increase the separation between the equipment and receiver.
- ✧ Connect the equipment into an outlet on a circuit different from that to which the receiver is connected.

✧ Consult the dealer or an experienced radio/TV technician for help.

Changes or modifications not expressly approved by the party responsible for compliance could void the user's authority to operate the equipment.

Turn on the HAC Setting

When the HAC setting is on, your C77 sends the audio from your phone calls to the telecoil rather than to the microphone of your hearing aid. You are likely to hear calls much better because volume is increased and background noise and feedback are diminished. The HAC setting improves only the calls you listen to through the earpiece. HAC requires extra battery power, so watch your battery consumption when it's turned on.

Copyright Notice

The video/audio recordings you make/download are protected by copyright laws. They are for personal use only and must not be otherwise used without the permission of the copyright owner.

2. Introduction

Overview

Thank you for purchasing the ZTE C77 Mobile Phone. The C77 is capable of making voice calls and data connections to CDMA 1x networks. It has the default functionality of E911 GPS. This phone provides many functions which are practical for daily use, including wireless internet browser, calendar, etc.

To guarantee this mobile phone is always in its best condition, read this manual carefully and keep it for future reference. To ensure your safety, read the section *For Your Safety* thoroughly before using this handset for the first time.

The pictures and icons shown in the manual are just schematic drawings for function demonstration. If they are inconsistent with your handset, please take your handset as the standard. If the inconsistency exists in the manual because of the handset function updating, please refer to the follow-up public information from ZTE Company.

What's Included

Your ZTE C77 Mobile Phone package contains the following components. Check the box carefully to ensure all items are present.

- C77 Handset

- Battery
- User Manual and literature pack
- AC Travel Charger

We, ZTE Corporation, declare that that the product is packaged with battery separate in the box. The FCC ID label is placed on the mobile phone clearly visible to all persons at the time of purchase.

C77 Technical Specifications

Handset Type	C77
Dimensions (L x W x H)	111.36 × 48.22 × 14.6 mm (4.38 × 1.90 × 0.57 in)
Weight	Less than 100 g (3.53 oz) including battery
Continuous Standby Time	180 hours (subject to the network)
Continuous Talk Time	220 minutes (subject to the network)

Phone at a Glance

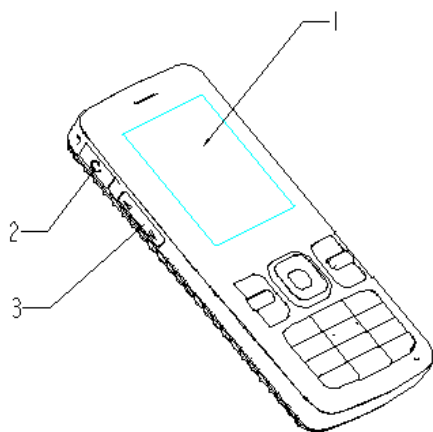



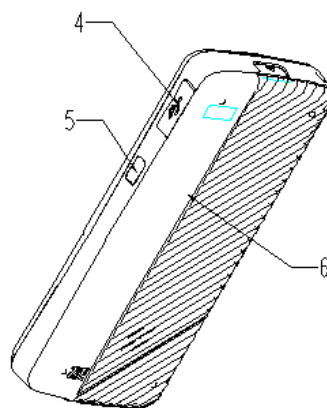



- [1] Display Screen
- [2] Handset Jack
- [3] Volume Key









- [4] USB Charger Port
- [5] Calendar Key
- [6] Battery Cover

Key Definitions

	<p>Left Soft Key – Execute prompts that appear in the lower-left corner of the screen, directly above the button. These prompts change according to the screen content.</p>
	<p>Right Soft Key – Execute prompts that appear in the lower-right corner of the screen, directly above the button. These prompts change according to the screen content.</p>
	<p>Send Key – Make and answer calls. This button is also a short cut key to “All Calls” from the idle screen.</p>
	<p>End Key – End calls and close applications. Holding this key for a while in the idle screen, it will power off the handset.</p>
	<p>Calendar Key – Holding this key for a while will launch the calendar in standby mode.</p>
	<p>Vol. up / Vol. down Keys– Adjusts the volume of calls and music play.</p>

C77 User Manual







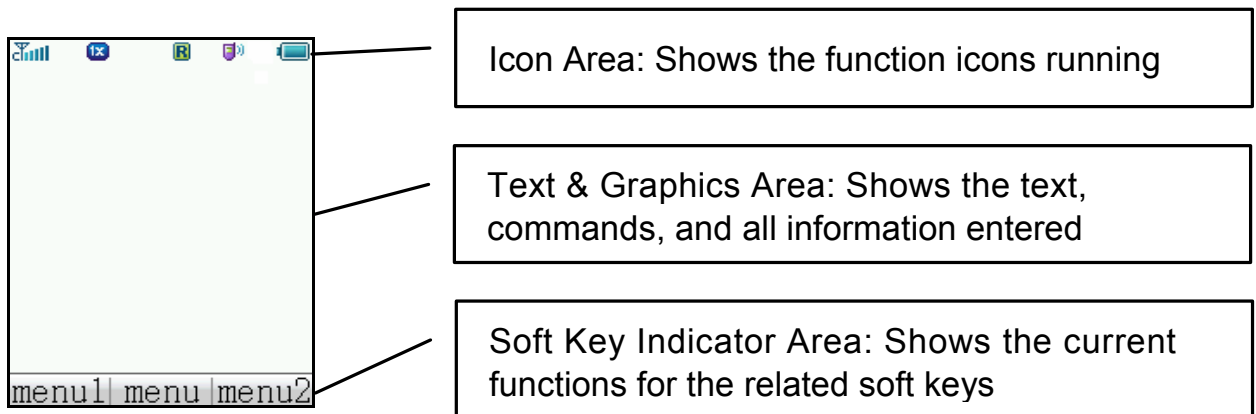





















	<p>Navigation Keys – These keys (up, down, left and right) allow for navigation through menu options. Use for quick access to All Contacts (Up), WEB (Left), Music & Media (Right) and Messaging (Down) when in standby mode.</p>
	<p>OK Key – Confirm actions and make selections. This key also executes prompts that appear on the lower-middle button on the screen, above the key. These prompts change according to screen content.</p>
	<p>0-9 Number/Alphabetic Keys – These keys are used for entering numbers and letters to a text, dialing a speed call, and selecting options while navigating menus. Press 1 key in standby mode to launch Voice Mail for shortcut.</p>
	<p>* and # Keys – These keys have different functions, depending on the mode or function menu. Hold the * key for a while in standby mode to switch between vibrate on and vibration off of your phone. Hold the # key to enter Keyguard mode.</p>
	<p>Back Key – Deletes characters during text entry. This key returns to the previous page during menu navigation and web browsing.</p>
	<p>Speaker Key – Activates and de-activates the speakerphone function during voice calls.</p>

User Interface

User Interface is constituted by three parts. They are icon area, text & graphic area, and soft key indicator area.



Indicators and Icons

	Signal Strength		1x Service
	Airplane Mode Is Active		Alarm Indicator
	Calendar		Call Connect
	Data Dormant		Data Transfer
	Earphone Mode		Incoming Calls
	Missed Calls		New MMS Message
	High MMS Priority		New MMS and SMS Message
	Battery Status		No Battery
	No Signal		Outgoing Calls
	Ringer Off		Ringer Mode
	Roaming		Silent Mode
	New SMS Message		High SMS Priority
	SSL (Web Security)		TTY Mode
	Vibration Mode		Vibration and Ringer Mode



New Voice Mail and Web
Message



New Voice Mail



New Web Message

3. Set up Your Phone

This chapter outlines the steps required to set up your phone, power-on and activate on your service provider's network. Follow the procedure below step-by-step to get started.

Battery

Please switch off your phone and disconnect the charger with it before removing the battery. Avoid touching electronic components on the battery and battery compartment of the phone.

Install the Battery

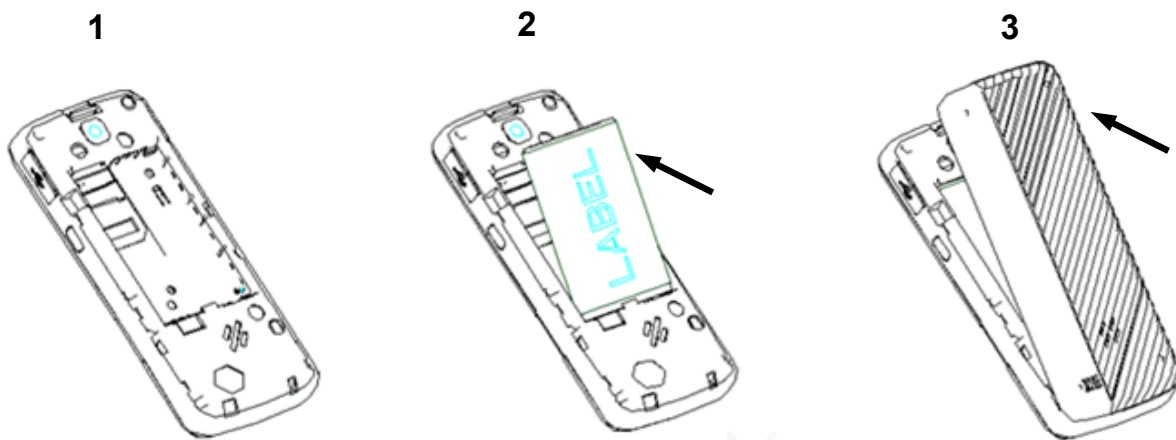

1. Make sure the + and – terminals on the battery be lined up with the metallic points in the battery compartment.
2. Insert battery to the plastic retainer clip and push down on the bottom section of the battery until it clicks into place. It should be aligned with the bottom of the phone.
3. Place the battery cover so that it covers the entire battery. Slide the cover until it locks into position. Make sure the battery cover is secure.

Charge the Battery

Your phone is powered by a rechargeable battery. The battery is not fully charged when you purchase your phone, but there may be enough power in the battery to turn the phone on. Charge the battery with the procedure indicated below.

Note: For maximum battery performance, it is recommended that you completely charge the battery before using the phone for the first time. A new battery's full performance is achieved only after three complete charge and discharge cycles.

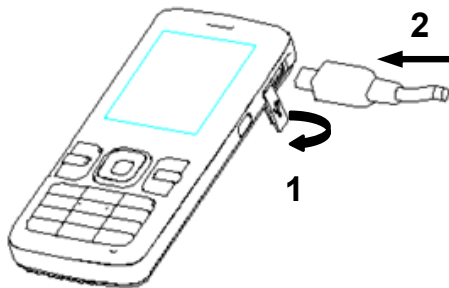

1. Pull the rubber USB cover out of the USB port and rotate it 90 degrees.
2. Insert the charger's USB adapter into the USB port. Ensure that the adapter is inserted with the correct orientation. Do not force the connector into the USB port.

Note: Make sure you plug the AC charger into a standard AC outlet box when you begin charging the battery.

Remove the Battery

If you need to remove your phone's battery, please follow the procedure indicated below:

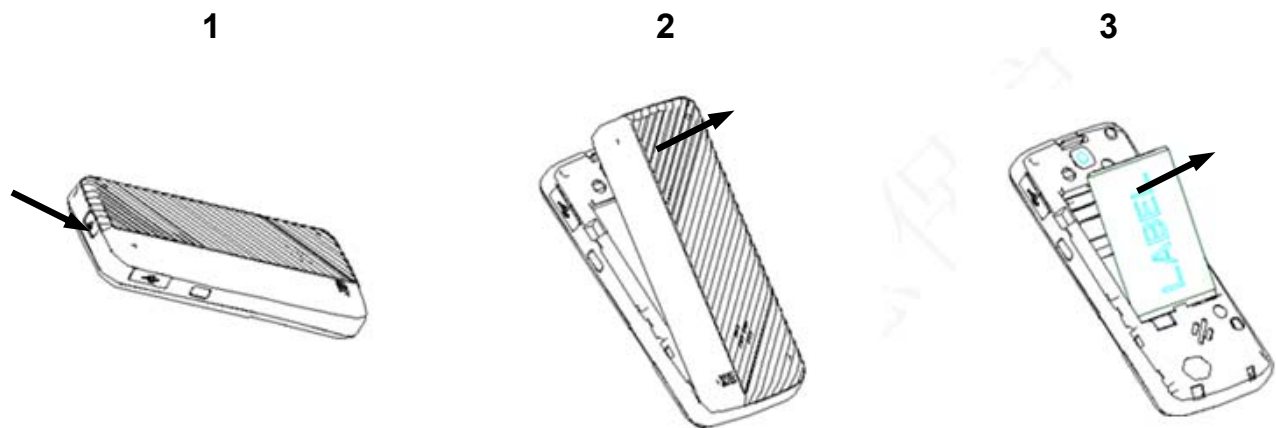

1. Slide the back cover toward the bottom of the phone and lift off the back cover.
2. Insert your fingernail into the finger grip the slot on the bottom of the battery. Lift the bottom of the battery away from the handset.
3. Remove the battery from the battery compartment.

Power On/Off Your Phone

To power on the phone, press and hold the **End** key for at least 3 seconds. If the handset lock code has been activated, the phone will prompt to enter the code. The default password for an inactivated phone is 0000. Once you have activated your handset, the default lock code will be the last 4 digits of your phone number.

It is also possible that the lock code has been updated by the user. If the updated lock code is lost or forgotten, please contact your service provider.

To power off the phone, press and hold the **End** key for at least 3 seconds from the idle screen.

Warning: Do not power the phone on when wireless phone use is prohibited, or when it may cause interference or danger.

Keyguard Mode

To prevent accidental pressing of keys, the C77 is equipped with the **Keyguard Mode** feature. To enter the Keyguard Mode, press and hold the **#** key of the phone while in standby mode.

To exit Keyguard Mode, press the "Unlock" on the Right Soft Key and then press the ***** key.

Connect to the Network

After your phone is unlocked, it will automatically search for the network.

Activate Your Phone

Before placing a call with your new phone, you must activate the phone on the network. To activate the phone, dial the provisioning number from the idle screen and follow the step-by-step instructions. Once the display indicates that programming is successful, the handset will restart automatically. You may then place a call with your handset.

4. Basic Operations

Make Voice Calls

Use the Keypad

1. Enter a phone number including the full area code by using the numeric keypad. If an incorrect character is entered, use the **Back** key to delete the digit. Pressing the **Back** key for a while will erase all digits before the cursor.
2. Press the **Send** key to make the voice call.
3. Press the **End** key to end the call, or to cancel the call attempt.

Note: To make an emergency call, enter the emergency number and press the **Send** key. If possible, remain stationary and keep the line connected.

Use the Contacts List

You can also make a call by choosing a record from your **Contacts**. To place a call from the contact list:

1. Choose the **Contacts** menu to display your contact list.
2. Scroll to the desired entry and press the **Send** key to make a call.

Use the Last Number Dialed

Your phone can re-dial the last number that was called. To dial the last number:

1. Press the **Send** key from standby mode.
2. Press the **Send** key again to dial the first entry.

Use the Number from the Call History

Generally, all calls you have made or received are saved in a list on the phone. All numbers are grouped into Missed Calls, Incoming Calls, and Outgoing Calls. To dial a number from your call history:

1. Select **Menu**→**Calls** from standby mode.
2. Navigate through the menu and press **OK** to select Missed, Incoming or Outgoing calls.
3. Select the phone number you want to dial from the list and press the **Send** key to place the call.

Use Speed Dials

Your phone is capable of storing 9 Speed Dial numbers that can be quickly dialed from standby mode. Among the nine digit buttons, the 1 is assigned to Voice Mail function. To use the Speed Dialing feature:

C77 User Manual

1. Press and hold the number key for the Speed Dial entry you would like to call.
2. The call will be connected automatically.
3. Press the **End** key to end the call, or to cancel the call attempt.

Note: If you have not already assigned a Speed Dial to the selected key, the phone will prompt that no Speed Dial has been assigned. You may click **Yes** to add a Speed Dial immediately. For more information on creating Speed Dials, Refer to section 6 in this manual.

Answer Voice Calls

When you receive a call, the ring tone, illumination, or vibration function will be activated, depending on your current settings. If the Caller ID function has been activated by the caller, the caller's phone number will be displayed. If the calling party use the service hiding their phone number, your phone will show that the phone number has been withheld.

To answer the call, press the **Send** or **OK** key. You can disconnect the call by pressing the **End** key.

Note: You can also enable the phone to answer calls automatically pressing any key on the keypad. The default setting can be changed in **Menu**→**Settings**→**System**→**Call Setup**→**Call Answer**.

In-Call Features

Volume

During a call, you can adjust the earpiece volume by pressing the volume keys on the side of the phone.

Mute

You can mute your voice during the call by pressing **Mute**, located on the right soft key. Pressing **Unmute** will allow the caller to hear your voice again.

Speakerphone

Your phone has a speakerphone function that allows you to talk hands-free with the use of the phone's external speakers. To talk with speakerphone, press the **Speaker** key on the keypad after the call has been connected. Press the **Speaker** key again to return to the standard call mode.

Advanced Features

To enter the advanced in-call features, press the **Options** during a call. The following will be available:

1. **Call the Third Party:** Call another number to activate three-way call feature.
2. **Messaging:** Switch to the message interface during the call.
3. **Contacts:** Switch to the contacts interface during the call.

4. **APP Mgr:** Switch to the dynamic application management interface during the call.

Three-Way Call

Your phone has a three-way calling feature, which enables you to have conference calls with two parties. You can activate this function by following the procedure below:

1. Once a voice call has been established with Party A, press the **Options** and select **Call the Third Party**.
2. The dialing window will appear. Enter the phone number of Party B and press **Send** key.
3. When the Party B answers the call, you will be connected with Party B only. Party A will remain on hold.
4. To activate the three-way call, press the **Send** key again. You will be able to converse with both parties simultaneously.
5. Press the **Send** key again to end the call with the Party B. You may press the **End** key to end both calls.

Call Waiting

Your phone can accept phone calls while another call is active. You can manage the phone's call waiting feature as follows:

1. If you receive a call during an active conversation, the phone will prompt that there

is an incoming call and allow you to accept or reject the call.







2. Press **Yes** on the left soft key to accept the call.
3. After accepting the call, you will be connected with the second caller, while the first party is put on hold. You may switch between callers by pressing the **Send** key again, or by selecting **Options**→**Swap**.
4. Press the **End** key to disconnect from the active caller.



Note: When the End key is pressed, both the active and holding user will be disconnected. If the holding user remains on the call, your phone will ring again. You may accept or reject the call.

Note: The 3-way calling and call waiting feature requires network support and may result in additional charges. Contact your service provider for more information.

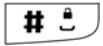
5. Entering Text





Key Functions

Key	Function	Description
	Left soft key	Execute prompts that appear in the lower-left corner of the screen, directly above the button.
	Right soft key	Execute prompts that appear in the lower-right corner of the screen, directly above the button.
	OK key	Confirm actions and make selections. This key also executes prompts that appear on the lower-middle button on the screen, above the button.
	Navigation Key	Move the cursor up and down, left and right during text editing.
	* key	Switch between Lowercase Alphabetic mode and Uppercase Alphabetic mode.
	# key	Insert a space for pressing once.
	End key	Exit.

	0-9 keys	Enter characters 0-9 and the alphabets from a-z. In text input mode, use key 1 to enter punctuations and symbols.
	Back key	Delete the previous character during text editing. Long pressing the Back key erases all text.

Text Input Modes

During text entry, you can press the display symbol button on the right soft key to select the input mode. The current mode is indicated on the right soft key menu among the following display symbols:

Display Symbol	Text Entry Mode
	Word predictive text mode
	Lowercase Alphabetic mode
	Uppercase Alphabetic mode
	Standard input mode
	Number mode

Alphabetic Mode

In Alphabetic mode, the alphanumeric keys from 2 to 9 are used to enter letters and numbers. You can enter the letters among the letters displayed on the keypad by pressing the keypad once and once again, and wait for a while until the underline of the entering letter disappears, the letter will be entered successfully. Take the 2 key for example:

There are letters “abc” on the keypad.

So press the 2 key once to enter the letter “a”, twice to enter the letter “b”, three times to enter the letter “c” and four times to enter number “2”, then continue pressing to start a new loop of “a” to “2”.

Note: Standard input mode is just the same as Alpha mode. But when composing sentences, the first letter of the new sentence will be capitalized automatically in standard input mode.

Word Mode

Word mode allows you to input messages or text quickly by using your keypad and the built-in predictive dictionary. To write a desired word, begin entering letters with the keys “a” to “z”. After part of the word has been entered, a list will be displayed on the menu bar with the most commonly used words containing the letters you have input.

As you enter more letters, the words in the predictive dictionary will be modified to reflect your current text. At any time, you may scroll down the list with the **Navigation Keys** or **0** key and select a desired word by pressing **OK** key. The complete word will be displayed in the editing window.

Number Mode

In Number mode, use alphanumeric keys from 0 to 9 to enter the number. You can only enter the number directly shown on the keypad. The letters can't be entered in this mode.

6. Contacts

Your phone has an address book capable of storing 500 contacts containing phone numbers, E-mail address and many other fields. To enter the contact list from standby mode, select **Menu**→**Contacts**.



This menu allows you to save and manage contact address information. In **Contacts** you can add a new address, or search saved contact addresses by name. You can also add a personal ringtone to a contact card.

Note: To quickly access the Contacts menu, press the right soft key named **Contacts** from standby mode.

Contact List









Select **Contact List** to view the list of all contacts stored on your phone. You may scroll up or down the list using the **Up/Down** Key, and press **OK** Key to view the desired contact information. Pressing **Options** will display the following pop-up menu:

1. **New Contact:** Add a new contact.
2. **Send Message:** Send a message to the contact.
3. **Delete:** Delete the selected record.
4. **Groups:** Display the groups interface.
5. **Set Speed Dial:** Assign the current number to one of the Speed Dial dialing keys. Speed dialing allows you to press and hold a number key in standby mode to call the stored phone number.
6. **Delete All:** Delete all records.
7. **Memory Info:** View the amount of Used, Available and Total records information.

You may also search for a contact from the **Contact List** screen. Type the name of the desired contact. Your input will be displayed at the bottom of the contact list. The phone will automatically scroll to the name that most closely matches your input.

New Contact

The **New Contact** menu allows you to add a new contact record. The following information can be stored for each contact:

-  **Name:** Contact name.
-  **Mobile1:** Mobile phone number.
-  **Home:** Home phone number.
-  **Office:** Office phone number.
-  **Mobile2:** Mobile phone number.
-  **Email:** Email address.
-  **Group:** Contact group (i.e., General, Family, Business, Personal, and VIP)
-  **Ringtone:** Ringtone to be played when receiving calls from the contact.
-  **Notes:** Other information about the contact.

Press the **OK** key to save the contact information. Press the **Back** key to exit from the **New Contact** interface.

Note: You may enter any of the contact information above; however, the name and a phone number or an E-mail address must be entered in order to save the contact.

Groups

The **Groups** menu allows you to add contacts to any of the five caller groups. The following are available from the Groups menu:

1. **Edit:** Rename the selected group
2. **Msg:** Switch to the contact list for the desired group. You can mark recipients from the group to whom you can send an MMS or SMS message.
3. **Select:** Switch to the contacts list of the current group

Speed Dials

The **Speed Dials** menu allows you to view the current list of speed dials and add new entries. Use the **Up/Down** Key to navigate to a desired speed dial number.

For speed dial numbers that are already assigned, click **View** to see the contact name and the phone number. You may also select **Dial** to call the contact, or **Clear** to remove the contact from the speed dials list.

To add a new speed dial, navigate to an empty speed dial number and press **List**. The contact list will be displayed. Navigate to the desired contact and press **Select** to add the contact to the speed dial list.

7. Calls

Your phone has a call history feature that automatically stores information about incoming, outgoing and missed calls. You may use the **Send** Key as a short cut key to **All Calls** from standby mode.



You may navigate through the Calls interface with the **Up/Down** Key and press **OK** Key to view the information below:

All Calls

List all calls of incoming, outgoing and missed.

Missed Calls

Display calls received but not answered.

Incoming Calls

Display calls received by the phone.

Outgoing Calls

Display calls made from the phone.

Call Timers

The **Call Timers** feature allows you to view the approximate duration of your calls, as well as data transferred and data connection time.

You can reset the information such as Last Call, Total Dialed Calls, Total Received Calls, Data Transferred, and Connection Time by selecting the **Reset** on the right soft key.

Note: The call timers are not intended for billing purposes. The actual invoice for calls and service provider may vary depending on network features, rounding off for billing, rates and so forth.

8. Messaging

Your phone has the functionalities of sending and receiving text messages (SMS Short Message Service), multimedia messages (MMS), and voice mail messages. To enter the messaging interface from standby mode, select **Menu**→**Messaging**.



Send New

The **Send New** selection is used to create and send a message with the composer. To create a message, enter a phone number in the **To** field. You may directly enter the recipient's number using the keypad. After entering one number or address, you may press **Add** to enter additional addresses.

You may also add recipients from your contact list by pressing the **Options**→**Contact**. Use the **Up/Down** Key to highlight the desired contact, and press the **Mark** key and

then press **Select** to select the contact. You may scroll down to select multiple recipients. After the desired numbers have been selected, press the **OK** to add the recipients to the message.

Note: You may send an SMS to a maximum of 10 recipients and an MMS to a maximum of 30 recipients, inclusive of the **To**, **Cc** and **Bcc** fields. These fields can each contain a maximum of 10 recipients.

When you have finished entering all recipients, press the **Down** Key to move the cursor to the lower window for creating your message text. For more information about text entry, refer to Section 5 – Entering Text.

Press the **OK** key to send the message. You can also save your message at any time by selecting **Options**→**Save To Drafts**.

Note: The maximum size of an MMS message is 350 KB and it may contain a combination of text, audio, and image.

Your phone allows you to perform a variety of other functions within the messaging window. Select **Options** to access the following features:

Insert

Your phone also allows you to add pictures and audio files to your message. From the messaging composition screen, select **Insert** to display the following options:

C77 User Manual

1. **MyImages:** Add an image from the folder lists.
2. **MyTunes:** Add an audio clip from the folder lists.

Slide

Enter the slide interface.

1. **Add Slide:** Switch to the slide interface.
2. **Delete Slide:** Delete the current slide.
3. **Previous Slide:** View the previous slide.
4. **Next Slide:** View the next slide, when more than one slide has been added.
5. **Slide Timing:** Set the duration (in seconds) for each slide.

Preview

Preview the message.

Erase Item

Erase the selected image and audio item from the message.

Cc/Bcc/Sub

View and enter the cc/bcc recipients and subject text. After inputting the desired information, press **Done** (or **Options - Done**) to save.

Save To Drafts

Save the message to the Drafts folder.

Quick Text

Quick Text messages are used to enter common responses to questions from a pre-defined dictionary. Select Quick Text, locate a desired phrase and click Select to add the text to the current message. For more information about Quick Text, refer to Settings - Quick Text Settings.

Signature

Input your pre-defined signature. See Settings – Message Settings – Signature for information on how to create a customized signature.

Message Priority

Set the priority for the message. If you set high priority to the message, it will be an exclamation mark displayed on the message icon when the message listed in the message box.

Inbox

The Inbox folder contains all of your received text and multimedia messages. From this folder you can review your received messages, reply or forward messages to another recipient. To access the inbox from standby mode, select **Menu**→**Messaging**→**Inbox**.

Read a Message

1. Use the **Up/Down** Key to select the desired message.
2. Press the **View**.
3. If the message is an SMS message or a downloaded MMS message, it will be displayed on the screen immediately.
4. If the message is an MMS message without download, an MMS notification will be displayed. Press the **Get** to download the message. The message will be downloaded and the phone will return to the Inbox. Highlight the downloaded MMS message and press **View**. The message will be displayed on the screen.
5. You may press the **Reply** to respond to the original recipient.

Reply to a Message

1. Highlight the desired message and press the **Reply** or **View→Reply**.
2. Compose your reply message. For more information about creating messages, refer to Send New.

Outbox

The Outbox folder contains all messages that were unsuccessfully sent during the last attempt. From this folder you can edit or re-send your message.

To edit a message before sending, press **Edit**. This will display the composer interface where you can edit your message. Select **Send** from this screen to send the message.

You can also send a message directly from the Outbox by pressing the **Send**.

Drafts

The Drafts folder contains drafts and unfinished text and multimedia messages. From this folder you can complete and re-send your messages. Select **Edit** to open the message, and press **Send** in the composer to send the message.

You may delete a highlighted message by pressing **Delete** and delete all the messages in the folder by pressing **Del. All**.

Sent

The Sent folder contains messages that have been successfully sent by your phone. Press **Edit** to open the composer interface to edit or re-send your message. You may also select **Delete** to delete the selected message from the Sent box.

Saved

The Saved folder contains saved text and multimedia messages. From this folder you can edit and resend your messages. The messages that are saved in this folder will not be deleted automatically.

You can view a saved message by highlighting the desired message and selecting **View**. You can also reply to messages by pressing **Reply**.

Voice Mail

When the Voice Mail function is available, all unanswered calls to your phone can be transferred to your voice mailbox, even if your phone is not being used or powered off. You should set up your voice mailbox and personal greeting as soon as your phone is activated. For more information, contact your service provider.

To check your voice mailbox, select Call from the Voice Mail interface. The phone will automatically place a voice call to the Voice Mail center. You may clear the new Voice Mail indicator by pressing Reset.

Shortcut: To quickly access your voice mailbox from standby mode, press and hold the 1 key. Your phone will automatically place a voice call to the Voice Mail center.

Web Alerts

Your phone is capable of receiving Web Alerts from online providers. For more details, contact your service provider. To access your Web Alerts:

1. From standby mode, select **Menu**→**Messaging**→**Web Alerts**.
2. Follow the on-screen instructions.

Settings

This menu allows you to customize the options to fit your preferences. From standby mode, select **Menu**→**Messaging**→**Settings** to access the settings menu.

Message Settings

1. **Save To Sent Box:** Set whether messages are saved to the Sent folder.
2. **Auto Delete Inbox:** If a new message comes, it will automatically delete the oldest message when the inbox is full.
3. **Default Entry Mode:** Set the default entry mode.
4. **Auto Download:** Set the preference for downloading MMS messages.

C77 User Manual

5. **Delivery Report:** Set on and off the delivery report.
6. **Picture Talk Alert:** Set on and off the picture talk alert.
7. **Callback:** Set the callback number that is sent along with SMS and MMS messages.
8. **Signature:** Allow you to input and save your message signature. The saved signature can be appended to all outgoing messages.

Quick Text Settings

The Quick Text Settings is a list of phrases that are commonly used in short messaging. To view or edit the phrase, press the **Edit**. For more information on adding Quick Text to your message, refer to Send New.

Memory Info

The Memory Info menu displays the amount of memory available for text and multimedia messages. Press the **OK** Key to exit from the menu.

9. Calendar

The Calendar allows you to conveniently access and modify your agenda. Simply store your appointment with a reminder and your phone will alert you on the time and date selected. You can access the Calendar by selecting **Menu**→**Calendar**.



Add an Appointment

To add an appointment to the Calendar, press **Add** on the right soft key. You may select to add a Meeting, Memo or Anniversary from the list.

View an Appointment

When you open your Calendar, it will automatically navigate to the current date. You may navigate the navigation keys to view appointments on a different date. To view

C77 User Manual

the details of an appointment, highlight the desired appointment and press the **View**. This will display various parameters such as the time, date, subject and location. You can manage the appointments in the view interface by **Edit** and **Delete**.

Calendar Options

To access the Calendar settings, press the **Options** located on the left soft key. The following options are available:

1. **Go To Date:** Input a date and press **OK** to jump to the specified date.
2. **Delete Entries:** Delete the In This Day, Before Date, and All Entries appointments.
3. **Settings:** Set the alarm tone and default calendar view (Month or Day view).
4. **Memory Info:** Displays the number of used, available and total calendar entries.

10. WEB

The browser feature on your phone allows you to view internet content. You can view specially designed versions of popular websites which include sports, weather, news, stock quotes and many others. As well, you can download ringtones and wallpapers from your service provider. To access the WEB in standby mode, select the **Menu**→**WEB**.



Launching and Navigating the Browser

When you choose **WEB** menu, you will be connected to the service provider's homepage automatically. You may press **Options** to access the browser submenu. The following selections are available:

1. **Home:** Go to the homepage.

C77 User Manual

2. **Forward:** Allow you to navigate one page forward from within cached web pages.
3. **Back:** Return to the previous web page which has just been viewed.
4. **Go To URL:** Switch to the URL screen where web addresses can be input.
5. **Bookmarks:** All previously accessed addresses can be saved as bookmarks on your phone.
6. **History:** Browse previously viewed web addresses.
7. **Screenshots:** Allow you to manage your screenshots.
8. **View URL:** Show the detail information of current URL and send the link as a message.
9. **Search Web:** Search via the search engine defined by your service provider.
0. **Advanced:** View the advanced menu for the Browser.
 - ✧ **Home:** Allow you to view the homepage URL.
 - ✧ **Multimedia:** Allow setting preferences for display pictures and background music.
 - ✧ **Clear Memory:** Allow clearing of the stored cookies, cache, etc.
 - ✧ **Scroll Mode:** Settings for the scroll mode and scroll speed of web pages.

- ◇ **Send Referrer:** Enable or disable adding "referrer" field into HTTP request head.
 - ◇ **Connection Timeout:** Set the duration of the connection timeout.
 - ◇ **Key Press Timeout:** Set the duration of the key press timeout.
 - ◇ **Security:** Set the security options.
- * . **Exit:** Exit Web Wireless and return to standby screen.
- # . **About:** Show the version of Web explorer.

11. Music & Media

Your phone has the capability to play music and view image. These functions are all accessible through the Music & Media menu. To access Music & Media, select **Menu** → **Music & Media** from standby mode.



MyTunes

The MyTunes selection allows you to manage the tunes in the phone. To access MyTunes folder from standby mode, select **Menu** → **Music & Media** → **MyTunes**.

Play Your Tunes

In the MyTunes interface when you highlight a tune, press **Play** to play the highlighted tune.

- Use **OK** key to start and pause the playing.
- Use **Back** key to stop the playing and exit from the player.

Manage Your Tunes

In the MyTunes interface, you can manage tunes files and send tunes via Message.

After highlighting a tune, press **Mark** to mark the tune and **Play** to play the tune. When you press **Options**, you can do the following:

1. **Send:** Send the tune via Message. Some files, such as MP3 music files, may be too large to send.
2. **Set As:** Set the tune as the default ringer of the phone.
3. **Rename:** Rename the tune.
4. **Delete:** Delete the tune.
5. **Mark All:** Mark all the tunes in the folder.
6. **File Info:** View the file property of the tune.
7. **DRM Digital Info:** View the DRM detail digital information. (This menu only displays for the DRM file)

MyImages

Your phone is able to manage the image in the format of JPG, GIF, BMP and PNG. You can view it, send it via the MMS and set it as the wallpaper. To access the Images folder from standby mode, select **Menu**→**Music & Media**→**MyImages**.

When you highlight a file, press **View** to view it. You can send it via MMS and set it as your phone's wallpaper in this function menu.

Preloaded Files

The preload files folder is a convenient way to organize all the preload tunes, images of your handset. To access the preload files folder from standby mode, select **Menu**→**Music & Media**→**Preloaded Files**. In this folder you will be able to access the folders Tunes, Images.

Tunes

After highlight a tune, the tune will be played automatically. You can set the desired tune to your own Call ID Ringer, Message Ringer, Alarm Ringer, etc, via **Set As**.

Images

When you highlight an image, you can view it by pressing **View** and set the image as the wallpaper via **Set As**.

After highlight a file and press **View**, you can get into the image viewing interface. In viewing interface you can view it with full screen by press **Full Scr** and set it as the wallpaper by pressing **Set As**.

Memory Info

The Memory Info selection allows you to view the details about the space used and available memory. To view the memory information from standby mode, select **Menu** → **Music & Media** → **Memory Info**.

12. Games

Your phone is capable of playing a variety of games that are available through your service provider. You can download games and store them on your phone for future use. To access the Games folder from standby mode, select **Menu**→**Games**.



Please follow the instructions on the screen to play the game.

13. Tools

The Tools menu provides helpful software applications to assist with daily tasks, such as a calculator, alarm clock, world clock etc. To access the Tools folder, select **Menu** → **Tools** from standby mode.



Calculator

Your mobile phone comes with a built-in calculator capable of performing addition, subtraction, multiplication and division. To access the calculator from standby mode, select **Menu** → **Tools** → **Calculator**.

1. Enter a number with the keypad.
2. If necessary, press the right soft key to insert a decimal point.
3. Use the navigation keys to select a mathematical function.

C77 User Manual





- ✧ **Up key:** add
 - ✧ **Down key:** subtract
 - ✧ **Left key:** multiply
 - ✧ **Right key:** divide
4. Enter the next number with the keypad.
 5. Press **Equal** to view the result.

Alarm Clock

The alarm function allows you to set up multiple separate alarms. To access the alarm clock function, select **Menu**→**Tools**→**Alarm Clock** from standby mode.

Edit an Alarm

To edit an alarm, highlight the desired alarm, select **Options**→**Set Alarm** to edit or create a new alarm by pressing **New**. You may set the alarm options described below:

-  **Type:** Set the alarm type.
-  **Date:** Select the date. This feature is only available for **Once** alarm type.
-  **Time:** Enter the time for the alarm format.
-  **Ringtone:** Select the Ringtone that will be played when the alarm sounds. This feature is hidden if the Ringtone is set to off.

 **Status:** Enable or disable the alarm.

 **Remark:** Enter a comment about the alarm.

You can save the alarm by pressing the **Save** key.

Alarm Options

To access the alarm settings, press **Options**. The following options are available:

1. **Set Alarm:** Edit the highlighted alarm entry.
2. **Set Rest Days:** Set the rest days that the alarm will not alert when the alarm in weekdays type.
3. **Delete All:** Delete all the alarms set.

If there are alarms that exist, then select **View** to view the alarm info. Press **Delete** if you want to cancel. And press **Edit** if you want to edit the viewed alarm.

Update Phone

The update phone function allows you to update PRL and profile. To access update phone function from standby mode, select **Menu**→**Tools**→**Update Phone**. The following options are available:

1. **Update PRL:** Update preferred roaming list from the network.

2. **Update Profile:** Update profile information from the network.

Tip Calc

The tip calculator function allows you to quickly and easily calculate the tip amount based on the tip rate and bill. You can access the Tip Calculator from standby mode by selecting **Menu**→**Tools**→**Tip Calc**. To calculate a tip:

1. Enter the Bill amount. Press **Decimal** to enter a decimal point.
2. Enter the Tip percentage.
3. Press **OK**.
4. The Tip and Total will be displayed.

You may press **Reset** to clear the bill and tip amount.

World Clock

The world clock displays the time in twenty-four different time zones around the world, together with one or more cities, states, regions or countries in each time zone. To access the World Clock, select **Menu**→**Tools**→**World Clock** from standby mode. Press the left and right navigation keys to display different time zones.

You may press the **DST** to enable or disable daylight savings time. The **Cities** sets the default time zone for the phone.

14. Settings

The settings menu allows you to customize your phone's display, sound, and various other settings based on your preferences. In standby mode, select **Menu**→**Settings** to access the settings menu.



Various phone settings are available within the **Settings** menu. Highlight the desired selection and press **Select** to view or change the current settings.

Sound Settings

The sound setting menu allows you to change the sound properties of your phone.

Ringers

Many different ringers are available to help you identify incoming calls and messages. You can assign ringtones to individual contact entries and types of calls or messages.

1. Voice Calls:

Caller ID: Edit the ringtone for calls with caller ID tags.

Unknown Calls: Set the ringtone from blocked or restricted phone numbers.

2. Messages:

Voice Mail: Select the Voice Mail indicator sound.

Messaging: Set the tone for new text and multimedia messages.

Web Alerts: Choose the indicator for new web alerts.

Reminder: Set the reminder time for new messages.

Press **Default** to set the ringers as initial ringer. Press **Edit** to edit the ringtone for types of ringers. To save the settings of ringer, you can press **OK** key.

Keypad Tone

The keypad tone menu allows you set the volume of the keypad tone.

Volume

The Volume menu sets the mode and volume options for the ringer and earpiece.

1. **Silent Mode:** Enable or disable silent mode.
2. **Master Volume:** Change the master volume level among Off, Vibrate only, four steps of Volume Level, etc.
3. **Earpiece:** Set the volume level among three steps of volume level for the earpiece of the wired headset accessory.

Power On/Off Tone

The Power On/Off setting allows you to enable or disable the music played during power on/off of the handset.

Alerts

The alerts menu allows you to change the sound settings for various alerts on your phone. To access the alerts menu, select **Menu**→**Settings**→**Sound Settings**→**Alerts** from standby mode. The following settings are available:

1. **Minute Beep:** Enable or disable the beep played before the calling time is about to achieve one minute.
2. **Call Connect:** Enable or disable the alert when a call is connected successfully.

3. **Call Lost:** Enable or disable the alert when a call is lost.
4. **Low Battery:** Enable or disable the low battery alert when the battery low.

Systems Switch Tone

You can turn on and off the systems switch tone with this function. When network switching happens and the function is on, the phone will alert a system switch tone at the moment.

Display Settings

The display settings allow you to customize your mobile phone's display screen. To access the display settings from standby mode, select **Menu**→**Settings**→**Display Settings**. The following settings can be changed via the display settings menu:

1. **Banner:** Edit the banner name displayed on standby mode.
2. **Wallpaper:** Select the background image from Images or MyImages for the standby mode.
3. **Backlight:** Set the screen and keypad backlight to be Always Off, 3 Seconds, 10 Seconds or 20 Seconds.
4. **Clock Format:** Change the format of the clock between Digital and Large Digital.
5. **Menu Style:** Choose between Icon and List menu style.
6. **Dialing Font:** Change the size of dialing font between Normal and Large.

Language

Your phone can display text in English or Spanish. To change the language settings, select **Menu**→**Settings**→**Language** from standby mode. Use the **UP** and **DOWN** keys to select between English and Spanish. Press **OK** to select the highlighted language.

GPS

The GPS menu allows you to check the GPS status information.

System

The System menu provides system settings.

Call Setup

The call setup menu allows you to change the answering features on your phone. To access the call setup menu from standby mode, select **Menu**→**Settings**→**System**→**Call Setup**. The following settings are available:

1. **Call Answer:** Set the way of answering a call.
2. **Auto Answer:** Set the auto-answer settings. This feature is intended for use when your phone is connected to an optional hands-free headset.
3. **Auto Redial:** Enable or disable the auto-redial feature. This feature automatically redials a call after an unsuccessful call.

Automatic Keyguard

The function allows you to lock your keypad automatically after the phone inactivates for 30 seconds in standby mode. You can activate this function as the follows:

1. Access via the path **Menu**→**Settings**→**System**→**Automatic Keyguard**;
2. Choose On and press **OK** to confirm.

Memory Info

The Memory Info menu allows you to view information about the phone's memory.

Phone Info

You can view the phone information such as the phone number, phone software version, etc.

System Settings

1. **Set Mode:** Select the mode of network.
2. **Set NAM:** Your phone has the capability of storing 2 different phone numbers. Use this setting to select the current Number Assignment Module (NAM). Contact your service provider for more information about the NAM.

Note: Additional fees may apply when roaming on another network.

TTY Mode

Your handset is a TTY compatible device. Simply connect the TTY equipment to the USB jack with the ZTE TTY-to-USB connector. To access the phone's TTY settings, select **Menu**→**Settings**→**System**→**TTY Mode**. Use the Up and Down keys to choose between the following settings:

1. **TTY Full:** Users who cannot talk or hear may use this setting to send and receive text messages through TTY equipment.
2. **TTY+Talk:** Users who can talk, but cannot hear, may use this setting to speak through the phone and receive responses via text message.
3. **TTY+Hear:** Users who can hear, but cannot speak, may use this setting to listen to conversation of the other party, and respond via text message.
4. **TTY Off:** Users who can hear and speak may use this setting to disable TTY support.

Connecting to TTY Equipment

1. Connect the cable from the TTY device into the ZTE TTY-to-USB connector.
2. Plug the USB connector into the jack on the right side of the phone.
3. Enter the TTY Mode menu and select the desired TTY Mode (shown above).
4. After setting the TTY mode, check the LCD screen on the phone for the TTY icon.

C77 User Manual

5. Connect the TTY equipment to the power source and turn it on.
6. Make a phone connection to the desired number.
7. When a connection is made, use the TTY equipment to send a text message, or speak (for TTY+Talk mode).
8. The voice or text message from the other party will be heard or displayed on the TTY equipment, depending on the TTY mode selected.

Security

The security menu allows you to lock your phone electronically. To access the Security menu, select **Menu**→**Settings**→**Security** from standby mode.

Note: You will need to enter the phone lock code to enter this menu. The default lock code is 0000. Once you have activated your handset, the lock code will be the last 4 digits of your phone number.

The following options are available:

Lock Mode: Choose between Unlock, Lock, and On Power Up. In Lock mode, the phone is only able to receive calls or make emergency calls. The On Power-Up setting will automatically lock your phone when it is powered on.

Change Code: This menu allows you to change the phone's lock pass code. To change your code:

1. Select **Menu**→**Settings**→**Security**→**Change Code** from standby mode.
2. When prompted, enter your old lock code.
3. Input the new code (1 to 8 characters).
4. Input the new code again to confirm.

Reset Defaults: This selection restores the default security settings.

HAC Mode

This phone supports HAC (Hearing Aid Compatibility) function. You can turn on and off the function by this menu. When you turn on the HAC mode and use a hearing aid with a Telecoil to answer the phone, it will help you hear more clearly while speaking on the phone.

For more detailed information of HAC, please refer to the section For Your Safety – Turn on the HAC Setting.

Airplane Mode On/Off

Airplane Mode allows you to use some features of your phone, such as games, calculator and many others when you are in an airplane or other area where RF signals may cause interference.

C77 User Manual

To enable **Airplane Mode**, select **Menu**→**Settings** from standby mode. Highlight **Airplane Mode: On** or **Airplane Mode: Off** and press **Select**.

15. Glossary

Abbreviation	Description
A2DP	Advanced Audio Distribution Profile
AC	Alternating Current
CDMA	Code Division Multiple Access
DST	Daylight Saving Time
HAC	Hearing Aid Compatibility
HFP	Hands-free Profile
HSP	Headset Profile
GPS	Global Positioning System
MMS	Multimedia Messaging Service
NAM	Number Assignment Module
OPP	Object Push Profile
PTT	Push To Talk
RF	Radio Frequency
SMS	Short Messaging Service
URL	Uniform Resource Locator
USB	Universal Serial Bus
VIP	Very Important Person

16. Troubleshooting

Fail to power on the phone

Check whether the battery has adequate capacity to power on.

The phone has auto powered off

The battery capacity is quite low, please charge the battery.

No key tone when pressing the keys

Key tone is not the necessary setting in main function. You can set key tone settings via the path **Menu**→**Settings**→**Sound Settings**.

No incoming ringtone when receiving a call

Check whether the phone is set to Silent Mode or the phone volume is turned off by the Volume key.

Can not send a message

Check the status of the network.

Can not auto answer an incoming call by the headset

Check whether Auto Answer is on in the call setup settings, via the path **Menu**→**Settings**→**System**→**Call Setup**.

To dial an emergency call

You can still dial an emergency call, even if the keypad is locked. Please enter the call number directly and press the **Send Key**.

Can not connect to the network

Check whether the phone is in the CDMA network service area or move other places to try again.

Can not receive a new message

Check whether the network condition is ok, and then check whether the Inbox is full. If you turn off the **Auto Delete Inbox** function, you may not receive new messages when the inbox is in full status. You should delete some messages and change the settings.

Can not establish Three-Way Call

Check the network condition and whether you have applied this service from your network provider.

17. Index

Activate Your Phone	37	Call Waiting	42
Aircraft Safety	13	Calls.....	38, 39, 52, 53, 78
Airplane Mode On/Off.....	85	Connect to the Network.....	37
Alarm		Contact List.....	49
Alarm Options.....	75	Contacts	28, 38, 41, 48
Edit an Alarm.....	74	Copyright Notice	23
All Calls.....	27, 52	Display Settings.....	80
Answer Voice Calls.....	40	Drafts	55, 57, 59
Basic Operations	38	Efficient Use	17
Battery		Emergency Services.....	18
Charge the Battery	34	Entering Text	44, 55
Install the Battery.....	33	FCC Notice	20
Remove the Battery.....	35	For Your Safety	10, 24, 85
C77 Technical Specifications	25	Games	72
Calculator.....	73, 75	General Care	10
Calendar	6, 7, 30, 63, 64	General Guidelines.....	14
Add an Appointment.....	63	Glossary	87
Calendar Options	64	GPS	24, 81, 87
View an Appointment	63	Groups.....	49, 51
Call Timers.....	53	Hospital Safety	14

<p>Images 70, 80</p> <p>Inbox 58, 61, 89</p> <p>In-Call Features..... 41</p> <p>Incoming Calls..... 39, 53</p> <p>Indicators and Icons 30</p> <p>Introduction 24</p> <p>Key Definitions 27</p> <p>Key Functions 44</p> <p>Keypad Mode..... 36</p> <p>Language 81</p> <p>Manage Your Tunes..... 69</p> <p>Memory Info 49, 62, 64, 71, 82</p> <p>Message Settings..... 57, 61</p> <p>Messaging.. 28, 41, 54, 58, 61, 78, 87</p> <p>Missed Calls..... 39, 53</p> <p>Music & Media..... 7, 68, 70, 71</p> <p>MyImages..... 56, 70, 80</p> <p>MyTunes 56, 68, 69</p> <p>New Contact..... 49, 50</p> <p>Outbox..... 59</p> <p>Outgoing Calls..... 39, 53</p> <p>Overview 24</p>	<p>Play Your Tunes68</p> <p>Power On/Off Your Phone36</p> <p>Quick Text Settings57, 62</p> <p>Radio Frequency (RF) Energy17</p> <p>Read a Message58</p> <p>Reply to a Message59</p> <p>Road Safety15</p> <p>Saved.....60</p> <p>Send New.....54, 59, 62</p> <p>Sent.....60, 61</p> <p>Set up Your Phone.....32</p> <p>Sound Settings</p> <p style="padding-left: 20px;">Alerts.....61, 79</p> <p style="padding-left: 20px;">Keypad Tone78</p> <p style="padding-left: 20px;">Power On/Off Tone.....79</p> <p style="padding-left: 20px;">Ringers78</p> <p style="padding-left: 20px;">Systems Switch Tone80</p> <p style="padding-left: 20px;">Volume.....41, 79, 88</p> <p>Speed Dials.....40, 51</p> <p>System</p> <p style="padding-left: 20px;">Automatic Keypad82</p> <p style="padding-left: 20px;">Call Setup40, 81, 88</p>
---	---

C77 User Manual

HAC Mode.....	85	Use the Call History to make calls ..	39
Memory Info	49, 62, 64, 71, 82	Use the Contacts List to make calls	38
Phone Info	82	Use the Keypad to make calls	38
Security	30, 67, 84, 85	Use the Last Number Dialed to make calls	39
System Settings	82	Use Your Phone with a Hearing Aid Device	21
TTY Mode.....	30, 83	User Interface	29
Text Input Modes	45	Vehicles Equipped with an Airbag ..	16
Third Party Equipment.....	17	Voice Mail	28, 31, 39, 60, 61, 78
Three-Way Call.....	42, 89	WEB	28, 65
Tip Calc.....	76	Web Alerts	61, 78
Tools	63, 73, 74, 75, 76	What's Included	24
Troubleshooting	88	World Clock	76
Tunes.....	70		
Turn on the HAC Setting	23, 85		
Use Speed Dials to make calls	39		

Consumer Limited Warranty

ZTE ("Seller") offers you a limited warranty that the enclosed product or products (the "Product") will be free from defects in material and workmanship for a period that expires one year from the date of sale of the Product to you, provided that you are the original end-user purchaser of the Product and provided that your purchase was made from a supplier authorized by the Seller. Transfer or resale of a Product will automatically terminate warranty coverage with respect to that Product. This limited warranty is not transferable to any third party, including but not limited to any subsequent purchaser or owner of the Product. This limited warranty is applicable only to end users in the United States.

Seller will, at its sole and absolute discretion, either repair or replace a Product (which unit may use refurbished parts of similar quality and functionality) if found by Seller to be defective in material or workmanship, or if Seller determines that it is unable to repair or replace such Product, Seller will refund the purchase price for such Product, provided that the subject Product (i) is returned to a Seller authorized service center within the one year warranty period, and (ii) is accompanied by a proof of purchase in the form of a bill of sale or receipted invoice which evidences that the subject Product is within the one year warranty period. After the one year warranty period, you must pay all shipping, parts and labor charges. In the event that the product is deemed un-repairable or has been removed from the list of products supported by the Seller, you will only be liable for shipping and labor charges.

C77 User Manual

This limited warranty does not cover and is void with respect to the following: (i) any Product which has been improperly installed, repaired, maintained or modified; (ii) any Product which has been subjected to misuse (including any Product used in conjunction with hardware electrically or mechanically incompatible or used with accessories not approved by Seller), abuse, accident, physical damage, abnormal operation, improper handling, neglect, exposure to fire or liquid; (iii) any Product operated outside published maximum ratings; (iv) cosmetic damage; (v) any Product on which warranty stickers or Product serial numbers have been removed, altered, or rendered illegible; (vi) cost of installation, removal or reinstallation; (vii) signal reception problems (unless caused by defects in material and workmanship); (viii) damage the result of fire, flood, acts of God or other acts which are not the fault of Seller and which the Product is not specified to tolerate, including damage caused by mishandling, shipping and blown fuses; (ix) consumables (such as fuses); or (x) any Product which has been opened, repaired, modified or altered by anyone other than Seller or a Seller authorized service center.

USE ONLY SELLER APPROVED ACCESSORIES WITH SELLER PHONES. USE OF ANY UNAUTHORIZED ACCESSORIES MAY BE DANGEROUS AND WILL INVALIDATE THE PHONE WARRANTY IF SAID ACCESSORIES CAUSE DAMAGE OR A DEFECT TO THE PHONE.

SELLER SPECIFICALLY DISCLAIMS LIABILITY FOR ANY AND ALL DIRECT, INDIRECT, SPECIAL, GENERAL, PUNITIVE, EXEMPLARY, AGGRAVATED,

INCIDENTAL OR CONSEQUENTIAL DAMAGES, EVEN IF ADVISED OF THE POSSIBILITY OF SUCH DAMAGES, WHETHER FORESEEABLE OR UNFORESEEABLE OF ANY KIND WHATSOEVER, INCLUDING BUT NOT LIMITED TO LOSS OF PROFITS, UNANTICIPATED BENEFITS OR REVENUE, ANTICIPATED PROFITS ARISING OUT OF USE OF OR INABILITY TO USE ANY PRODUCT (FOR EXAMPLE, WASTED AIRTIME CHARGES DUE TO THE MALFUNCTION OF A PRODUCT) OR CONTRIBUTION OR INDEMNITY IN RESPECT OF ANY CLAIM RELATED TO A PRODUCT.

REPAIR OR REPLACEMENT OF A DEFECTIVE PRODUCT OR REFUND OF THE PURCHASE PRICE RELATING TO A DEFECTIVE PRODUCT, AS PROVIDED UNDER THIS WARRANTY, ARE YOUR SOLE AND EXCLUSIVE REMEDIES FOR BREACH OF THE LIMITED WARRANTY, AND SUBJECT TO THIS WARRANTY, THE PRODUCTS ARE APPROVED AND ACCEPTED BY YOU "AS IS". SELLER MAKES NO OTHER WARRANTIES, REPRESENTATIONS OR CONDITIONS OF ANY KIND, ORAL OR VERBAL, EXPRESS OR IMPLIED, STATUTORY OR OTHERWISE, WITH RESPECT TO THE PRODUCTS, INCLUDING BUT NOT LIMITED TO ANY IMPLIED WARRANTY OR CONDITION OF MERCHANTABILITY OR FITNESS FOR A PARTICULAR PURPOSE OR AGAINST INFRINGEMENT OR ANY IMPLIED WARRANTY OR CONDITION ARISING OUT OF TRADE USAGE OR OUT OF A COURSE OF DEALING OR COURSE OF PERFORMANCE. NO DEALER, DISTRIBUTOR, AGENT OR EMPLOYEE IS AUTHORIZED TO MAKE ANY MODIFICATION OR ADDITION TO THIS WARRANTY.

C77 User Manual

Some jurisdictions do not allow the exclusion or limitation of incidental or consequential damages, or allow limitations on how long an implied warranty lasts, so the above limitations or exclusions may not apply to you. This limited warranty gives you specific legal rights, and you may also have other rights which vary from jurisdiction to jurisdiction.